



GUIA DE PRODUTOS



INSTRUÇÕES GERAIS

FAMÍLIA

- 01 - MVS para registros de pressão
- 02 - MVS para torneiras
- 03 - Sifões tubos extensivos
- 04 - MVS para bidês e lavatórios
- 05 - Hastes para registros de gaveta
- 06 - Kit Fácil
- 07 - Volantes para registros
- 08 - Canoplas para registros e torneiras
- 09 - Acabamentos para registros
- 10 - Acessórios complementares
- 11 - Extensores para torneiras
- 12 - Adaptadores para arejadores de torneiras
- 13 - Conversores para registros
- 14 - Estrias para registros
- 15 - Conversores para válvulas de descarga
- 16 - Prolongadores para registros e torneiras
- 17 - Conexões
- 18 - Acessórios para instalações de gás
- 19 - Torneiras e desviadores
- 20 - Acessórios para duchas higiênicas
- 21 - Ligações flexíveis para duchas higiênicas
- 22 - Ligações flexíveis com duchas higiênicas
- 24 - Duchas higiênicas
- 25 - Ligações flexíveis para água
- 28 - MVS para registros de gaveta
- 29 - Acessórios para banheiros
- 30 - Mecanismos para misturadores monocomando
- 31 - Acessórios para filtros domésticos
- 32 - Ferramentas Blukit
- 33 - Válvulas
- 34 - Sistemas de descarga
- 35 - MVC para registros de pressão
- 36 - MVC para torneiras
- 37 - MVC para bidês e lavatórios
- 38 - Acessórios para jardim
- 39 - Resistências elétricas
- 40 - MVS em PPS para registros
- 41 - MVS em PPS para torneiras
- 42 - MVC em PPS para torneiras
- 43 - Sede para registros

ENTENDA A REFERÊNCIA

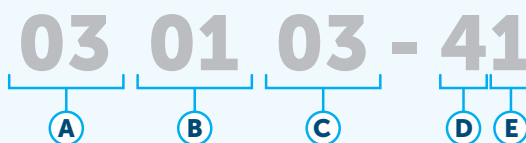

- A** 03 = **FAMÍLIA** (Sifões tubos extensivos)
- B** 01 = **FAMÍLIA TIPO OU MARCA**
- C** 03 = **SEQUÊNCIA** (01, 02, 03)
- D** 4 = **TIPO DE EMBALAGEM**
- E** 1 = **QUANTIDADE**

TIPOS DE EMBALAGENS

- 0 = SEM EMBALAGEM
- 2 = BLISTER ENCARTELADO
- 3 = CAIXA
- 4 = SACO PLÁSTICO
- 6 = BLISTER ESTOJO

CONSIDERAÇÕES

Os nomes dos produtos citados neste guia são de propriedade dos seus respectivos fabricantes, servindo apenas para demonstrar a compatibilidade dos nossos produtos.

Os padrões de rosca mencionados neste guia referem-se ao gabarito de rosca Blukit.

A Blukit se compromete em buscar, constantemente, o aperfeiçoamento dos seus produtos. Por isso, qualquer alteração nos mesmos, não haverá prévio aviso.

Imagens meramente ilustrativas, não restritivas.

Representante:

Telefone:

MULTICANAIS BLUKIT

Portal do Lojista:

portaldolojista.blukit.com.br

Contatos:

47 3331-0800

comercial@blukit.com.br

blukit.com.br    /canalblukit

Baixe a versão digital
no seu celular
ou tablet



Acesse www.blukit.com.br/downloads

ÍNDICE

Acabamentos	55	Kit Fácil® Registro de Pressão e Torneiras	29
Acessórios para Banheiro	28	Ligações Flexíveis	12
Acessórios (Chave de acesso, abraçadeiras e parafusos) 60		Mecanismos de Descarga	13
Acessórios para Duchas	27	Mecanismos de Descarga (Acessórios)	16
Anéis de Vedação	11	Mecanismos para Misturador	50
Anéis O'ring em Tamanho Real	33	MVC - Mecanismo de Vedação Cerâmica (1/4 de Volta)	35
Conexões - Água e Filtros	62	MVS - Mecanismo de Vedação Substituível (Gaveta)	48
Conversão para Deca Dream / Polo	51	MVS - Mecanismo de Vedação Substituível (Pressão, torneiras e misturadores)	38
Conversores para Registros	52	Prolongadores para Registros	53
Duchão	23	Sifões Tubos Extensivos	04
Economizadores de Água	71	Torneiras	74
Extensores	73	Torneiras de Boia	24
Fitas Veda Rosca	22	Tubos de Ligação	11
Gás	67	Válvulas de Descarga	18
Kits Duchas Higiênicas	25	Válvulas de Escoamento	09
Kit Fácil® Registro de Gaveta	46	Válvulas e Registros	61
Kit Fácil® Salva Registro® 9 Em 1	34		
Kit Fácil® Salva Registro® 10 Em 1	34		
Kits para Caixa Acoplada	14		

Seja um solucionador Blukit!
Conecte nossas mais diversas soluções
com quem está buscando!



SIFÕES TUBOS EXTENSIVOS

PRODUTO EXCLUSIVO

Vedantes Destacáveis

PARA SIFÃO TUBO EXTENSIVO



Diâmetro: máx. 110 mm x min. 31 mm

Enviado junto com cada sifão tubo extensivo



Seja para **cozinha, tanque** ou **lavatório**, você pode escolher o **vedante** mais adequado para instalação do seu **sifão**!



Bitola: 1.1/2
Diâmetro do produto: 110 mm



Bitola: 1.1/4
Diâmetro do produto: 48 mm



Bitola: 7/8
Diâmetro do produto: 42 mm

Ref. 030140



ACOMPANHA SUPORTE PRETO



ACOMPANHA CANOPLA PRETO

Ref. 030105



ACOMPANHA SUPORTE CINZA

Ref. 030101



ACOMPANHA SUPORTE BRANCO

Ref. 031101



ACOMPANHA SUPORTE CINZA

ACOMPANHA CANOPLA CROMADA

Sifão Tubo Extensivo

UNIVERSAL

Plásticos de engenharia e elastômeros

Comprimento: 70 cm (máx) x 29 cm (min)
Entrada universal: 1.1/2 - 1.1/4 - 7/8
Saída 4 em 1: DN38 x DN40 x DN48 x DN50
Temperatura máxima: 90 °C



Fabricado no Brasil

1

nº 1 em Vendas

Ref. 030101 - branco **(+VENDIDO)**
Ref. 030105 - cinza
Ref. 030102 - branco **com porca de liga de cobre**
Ref. 030140 - preto **com canopla**
Ref. 031101 - cromado **com canopla (+VENDIDO)**
Ref. 031105 - cromado **sem canopla**





SOMENTE NO PRETO
ACOMPANHA CANOPLA

ACOMPANHA SUPORTE



Sifão Tubo Extensivo 1,10m

UNIVERSAL
Plásticos de engenharia e elastômeros

Comprimento: 110 cm (máx) x 40 cm (mín)
Entrada universal: 1.1/2 - 1.1/4 - 7/8
Saída 4 em 1: DN38 x DN40 x DN48 x DN50
Temperatura máxima: 90 °C

Ref. 030138 - 1,10 m - branco
Ref. 030141 - 1,10 m - preto com canopla



Sifão Tubo Extensivo 1,50 m

UNIVERSAL
Plásticos de engenharia e elastômeros



Versão de 1,50 m: 1,50 m (máx) x 54 cm (mín)
Versão de 2,0 m: 2,0 m (máx) x 64 cm (mín)
Entrada universal: 1.1/2 - 1.1/4 - 7/8
Saída 4 em 1: DN38 x DN40 x DN48 x DN50
Temperatura máxima: 90 °C

Ref. 030129 - 1,50 m - branco **(+VENDIDO)**
Ref. 031103 - 1,50 m - cromado **com canopla**
Ref. 031106 - 1,50 m - cromado **sem canopla**
Ref. 030127 - 1,50 m - branco **com porca de liga de cobre**
Ref. 030132 - 2,0 m - branco



COM PORCA DE LIGA DE COBRE

ACOMPANHA CANOPLA

ACOMPANHA SUPORTE

ACOMPANHA SUPORTE CINZA

ACOMPANHA SUPORTE



ACOMPANHA 2 SUPORTES

Sifão Tubo Extensivo 1,10m

DUPLO UNIVERSAL
Plásticos de engenharia e elastômeros

Comprimento: 110 cm (máx) x 42 cm (mín)
Entrada universal: 1.1/2 - 1.1/4 - 7/8
Saída 4 em 1: DN38 x DN40 x DN48 x DN50
Temperatura máxima: 90 °C

Ref. 030213 - 1,10 m - branco



DUPLO ATÉ 1,10m

SIFÕES TUBOS EXTENSIVOS



ACOMPANHA CANOPLA

ACOMPANHA CANOPLA

ACOMPANHA 2 SUPORTES

Sifão Tubo Extensivo Duplo

DUPLO UNIVERSAL
Plásticos de engenharia e elastômeros



Comprimento: 70 cm (máx) x 33 cm (mín)
Entrada universal: 1.1/2 - 1.1/4 - 7/8
Saída 4 em 1: DN38 x DN40 x DN48 x DN50
Temperatura máxima: 90 °C

- Ref. 030205 - branco **(+VENDIDO)**
- Ref. 031601 - cromado **com canopla**
- Ref. 031602 - cromado **sem canopla**
- Ref. 030206 - branco **com porca em liga de cobre**
- Ref. 030211 - cinza
- Ref. 030214 - preto **com canopla**



Sifão Universal com Copo

INDICADO PARA COZINHA
Plásticos de engenharia e elastômeros

Comprimento: 70 cm (máx) x 29 cm (mín)
Entrada universal: 1.1/2 - 1.1/4 - 7/8
Saída 4 em 1: DN38 x DN40 x DN48 x DN50
Temperatura máxima: 90 °C

- Ref. 031301 - branco **(+VENDIDO)**
- Ref. 031701 - cromado
- Ref. 031309 - preto



somente o **COPO**
Ref. 030424

LANÇAMENTO



ACOMPANHA CANOPLA



ACOMPANHA CANOPLA

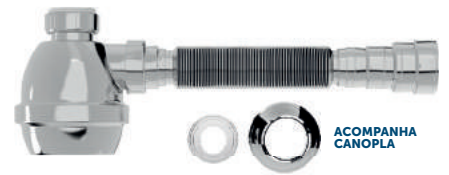

ACOMPANHA CANOPLA

SUPER COMPACTO

LANÇAMENTO



Sifão Copo de Parede

INDICADO PARA LAVATÓRIO
Plásticos de engenharia e elastômeros

Comprimento: 47 cm (máx) x 28 cm (mín)
Entrada universal: 1.1/2 - 1.1/4 - 7/8
Saída: DN38
Temperatura máxima: 90 °C

- Ref. 031303 - branco
- Ref. 031703 - cromado
- Ref. 031311 - preto



LANÇAMENTO



Sifão Universal com Copo

INDICADO PARA LAVATÓRIO
Plásticos de engenharia e elastômeros

Comprimento: 55 cm (máx) x 32 cm (mín)
Entrada universal: 1.1/2 - 1.1/4 - 7/8
Saída 4 em 1: DN38 x DN40 x DN48 x DN50
Temperatura máxima: 90 °C

Ref. 031302 - branco
Ref. 031702 - cromado
Ref. 031310 - preto



Sifão Universal com Copo Duplo

Plásticos de engenharia e elastômeros

Comprimento: 70 cm (máx) x 33 cm (mín)
Entrada universal: 1.1/2 - 1.1/4 - 7/8
Saída 4 em 1: DN38 x DN40 x DN48 x DN50
Temperatura máxima: 90 °C

Ref. 031307 - branco

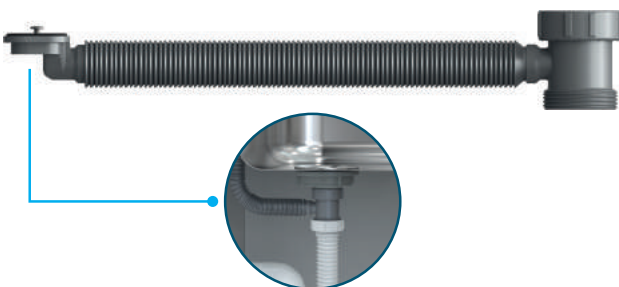

Tubo Extravasor (Ladrão)

INDICADO PARA COZINHA
PARA CUBAS EM AÇO INOXIDÁVEL
Plásticos de engenharia e elastômeros

Comprimento: 58 cm (máx) x 34 cm (mín)
Rosca: 1 1/2
Temperatura máxima: 90 °C

Ref. 030447 - cinza

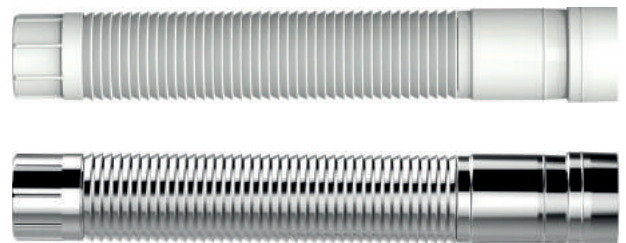

Tubo Extensivo

INDICADO PARA LAVATÓRIO
Plásticos de engenharia e elastômeros

Comprimento: 70 cm (máx) x 26 cm (mín)
Diâmetros de saída: DN38 x DN40
Temperatura máxima: 90 °C

Ref. 030103 - branco
Ref. 031102 - cromado



SIFÕES TUBOS EXTENSIVOS



Sifão Tubo Extensivo

UNIVERSAL
COM JOELHO DE 90°
Plásticos de engenharia e elastômeros



Comprimento: 70 cm (máx) x 29 cm (mín)
Entrada universal: 1.1/2 - 1.1/4 - 7/8
Saída 4 em 1: DN38 x DN40 x DN48 x DN50

Ref. 030124 - branco

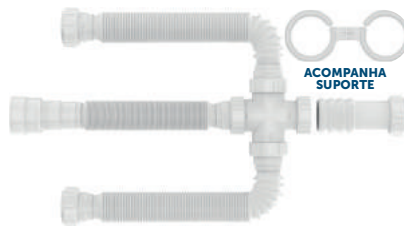

Sifão Tubo Extensivo

PARA CUBA TRIPLA
Plásticos de engenharia e elastômeros



Comprimento: 70 cm (máx) x 29 cm (mín)
Cruzeta: 1 1/2
Entrada universal: 1.1/2 - 1.1/4 - 7/8
Saída 4 em 1: DN38 x DN40 x DN48 x DN50
Temperatura máxima: 90 °C

Ref. 030406 - branco
Ref. 030420 - branco - com mangueira de saída para máquina de lavar



Mangueira de Entrada

PARA MÁQUINA DE LAVAR
Plásticos de engenharia



Terminal: 90°
Pressão máxima: 40 m.c.a.
Rosca: 3/4
Temperatura máxima: 45 °C

Ref. 031001 - cinza - comprimento 1,20 m
Ref. 031002 - cinza - comprimento 1,40 m
Ref. 031003 - cinza - comprimento 1,80 m



Adaptador Articulado 45° com Retenção

PARA SAÍDA DE MÁQUINA DE LAVAR
Plásticos de engenharia e elastômeros

Entrada para mangueiras: 7/8, 3/4 e 1
Saída: DN38 e DN40
Temperatura máxima: 110 °C

Ref. 030448 - cinza

Evita o retorno de mau cheiro e espuma após escoamento da água.

PRODUTO PATENTEADO EXCLUSIVO **Blukit**

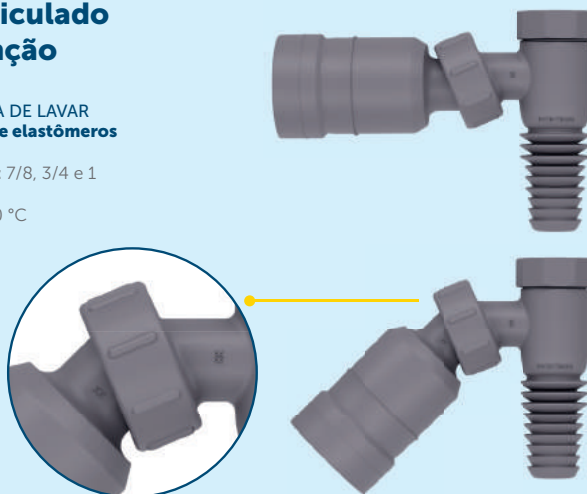

Ajuste perfeito no comprimento

Terminais emborrachados = fácil adaptação

Mangueira de Saída Extensiva

PARA MÁQUINA DE LAVAR ROUPA E LAVA-LOUÇA UNIVERSAL
Plásticos de engenharia



Acabamento cinza
Terminais: DN19 x DN21,5 x DN26 x DN29
Temperatura máxima: 45 °C

Ref. 030301 - 2,2 m (máx) x 78 cm (mín) **(+VENDIDO)**
Ref. 030312 - 4,0 m (máx) x 1,6 m (mín)



Conexão

PARA MÁQUINAS DE LAVAR
Plásticos de engenharia e elastômeros



Diâmetro das conexões: 1.1/2 (x4)
Espigão 3 em 1: 1/2 x 3/4 x 1
Acompanha uma cap de 1.1/2
Temperatura máxima: 90 °C

Ref. 030402 - branco

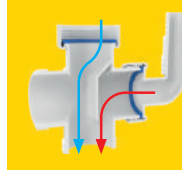

EXCLUSIVO SISTEMA INTERNO

Evita que a água volte para dentro da pia.





PRODUTO
PATENTEADO
EXCLUSIVO

Blukit

Tubo Extensivo

PARA LIGAÇÃO DE
VÁLVULA DE DESCARGA
Plásticos de engenharia, ligas de cobre e elastômeros

Comprimento: 25 cm (máx) x 14 cm (mín)
Diâmetros de saída: DN36 x DN38
Porca em liga de cobre: 1.1/2
Temperatura máxima: 90 °C

Ref. 030120 - branco



Fabricado no Brasil



Prolongador

PARA VÁLVULA
Plásticos de engenharia e elastômeros

Comprimento: 100 mm
Diâmetro (G): 1.1/2 x 1.1/4 x 7/8 (M x F)

Ref. 030414 - branco
Ref. 030423 - cromado



Fabricado no Brasil



Ajustável em qualquer bitola!

Canopla

PARA SIFÃO TUBO EXTENSIVO
Plásticos de engenharia

Altura (canopla): 20 mm
Diâmetro externo: 95 mm x 65 mm x 65 mm
Diâmetro interno: DN38 x DN40 x DN48 x DN50

Ref. 030450 - branco
Ref. 030449 - cromado



Fabricado no Brasil

VÁLVULAS DE ESCOAMENTO



Válvula de Escoamento

PARA PIA AMERICANA
Plásticos de engenharia e aço inoxidável

Aba: 111 mm
Bitola: 4.1/2 x 1.1/2
Comprimento: 62 mm

Ref. 101609 (+VENDIDO)



Fabricado no Brasil



Válvula de Escoamento

PARA PIA AMERICANA
Plásticos de engenharia e aço inoxidável

Aba: 88 mm
Bitola: 3.1/2 x 1. 1/2
Comprimento: 62 mm

Ref. 101610 (+VENDIDO)



Fabricado no Brasil



Válvula de Escoamento

PARA LAVATÓRIO
Plásticos de engenharia e aço inoxidável

Aba: 55 mm
Bitola: 7/8
Comprimento: 35 mm

Ref. 101617



Fabricado no Brasil

LANÇAMENTO



Válvula de Escoamento

PARA TANQUE E LAVATÓRIO



Fabricado no Brasil

Aba: 55 mm
Bitola: 7/8
Comprimento: 70 mm
Aplicação: Lavatório
Plásticos de engenharia
Ref. 101645 - preto
Ref. 101615 - branco (+VENDIDO)
Ref. 101616 - inoxidável

Aba: 71 mm
Bitola: 1 1/4
Comprimento: 74 mm
Aplicação: Tanque
Plásticos de engenharia
Ref. 101646 - preto
Ref. 101629 - branco
Ref. 101630 - inoxidável (+VENDIDO)



Válvula de Escoamento

PARA TANQUE E LAVATÓRIO

Liga de cobre
Tampa branca
Aba: 55 mm
Bitola: 7/8
Comprimento: 70 mm
Aplicação: Lavatório
Ref. 101637 - cromado (+VENDIDO)

Aba: 60 mm
Bitola: 1 1/4
Comprimento: 70 mm
Aplicação: Tanque
Ref. 101638 - cromado (+VENDIDO)



Válvula de Escoamento

LONGA PARA LAVATÓRIO

Liga de cobre
Acabamento Cromado
Aba: 60 mm
Bitola: 7/8
Comprimento: 130 mm

Ref. 101641

VÁLVULAS DE ESCOAMENTO



Válvula de Escoamento

OCULTA PARA CUBA

Aba: 49 mm
Bitola: 7/8
Comprimento: 68 mm
Acabamento Cromado

Liga de cobre
Ref. 101628
Plásticos de engenharia e elastômeros
Ref. 101632



CLIQUE!
+ CONFORTO
+ PRÁTICO



Válvula de Escoamento Modelo Clique

PARA TANQUE E LAVATÓRIO

Liga de cobre, plásticos de engenharia, elastômeros

Bitola: 1.1/4	Bitola: 7/8
Aplicação: Tanque	Aplicação: Lavatório
Comprimento: 78 mm	Comprimento: 68 mm
Tampa: 66 mm	Tampa: 57 mm
Ref. 101639 - cromado	Ref. 101643 - cromado



CLIQUE!
+ CONFORTO
+ PRÁTICO



Válvula de Escoamento Modelo Clique

PARA TANQUE E LAVATÓRIO

Liga de cobre, plásticos de engenharia e elastômeros

Bitola: 1.1/4	Bitola: 7/8
Aplicação: Tanque	Aplicação: Lavatório
Comprimento: 70 mm	Comprimento: 68 mm
Tampa: 62 mm	Tampa: 56 mm
Ref. 101640 - cromado	Ref. 101642 - cromado



Vedante Universal

PARA VÁLVULAS DE ESCOAMENTO

Diâmetro: mín.31 mm x máx.110 mm

Ref. 101702 (EVA adesivo)

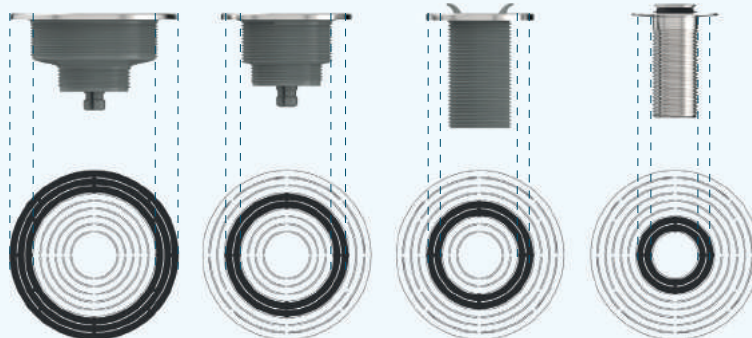

Bitola: 4.1/2 e 3.1/2	Bitola: 1.1/2	Bitola: 1.1/4	Bitola: 7/8
Diâmetro do produto: 110 mm	Diâmetro do produto: 48 mm	Diâmetro do produto: 42mm	Diâmetro do produto: 29,5mm



Prolongador

PARA VÁLVULA DE ESCOAMENTO DE LAVATÓRIO

Liga de cobre
Bitola: 7/8
Rosca: 50 mm comprimento
Comprimento total: 60 mm

Ref. 172004 - cromado



Prolongador

PARA VÁLVULA DE ESCOAMENTO DE LAVATÓRIO

Liga de cobre
Bitola: 7/8
Rosca: 30 mm comprimento
Comprimento total: 60 mm

Ref. 172001 - cromado



Tampa

PARA VÁLVULAS DE TANQUES, LAVATÓRIOS E BANHEIRAS

Plásticos de engenharia



Ref. 100401 - Bitola - 1 (26 mm) **(+VENDIDO)**
Ref. 100402 - Bitola - 1 1/16 (27,5 mm)
Ref. 100403 - Bitola - 1 1/8 (29 mm)
Ref. 100404 - Bitola - 1 3/16 (31 mm)
Ref. 100405 - Bitola - 1 3/8 (36 mm) **(+VENDIDO)**
Ref. 100406 - Bitola - 1 1/2 (38,5 mm) **(+VENDIDO)**
Ref. 100407 - Bitola - 1 5/8 (42 mm)
Ref. 100408 - Bitola - 1 7/8 (47,5 mm)



Vedante Cônico

PARA VÁLVULA DE ESCOAMENTO DE LAVATÓRIO

Elastômeros
Altura: 18 mm
Diâmetro externo: 73 mm
Diâmetro interno: 35,5 mm

Ref. 101716



Anel de Vedação

PARA VÁLVULA DE ESCOAMENTO

Termoplástico
Bitola: 7/8
Diâmetro externo: 57mm
Diâmetro interno: 32mm
Espessura: 2mm

Ref. 101703



LANÇAMENTO TUBO AJUSTÁVEL



Tubo de Ligação

AJUSTÁVEL | PARA VASO SANITÁRIO
Plásticos de engenharia

Comprimento: 260 mm
Diâmetro: DN38

Ref. 290419 - preto
Ref. 290403 - branco
Ref. 290404 - cromado (+VENDIDO)
Ref. 030446 - cromado - sem espude
Ref. 290406 - espude 65mm
Ref. 290413 - espude 76mm



Fabricado no Brasil

TUBO RÍGIDO



Tubo de Ligação

RÍGIDO | PARA VASO SANITÁRIO
Plásticos de engenharia e elastômeros

Comprimento: 260 mm
Diâmetro: DN38

Ref. 290410 - branco
Ref. 290411 - cromado
Ref. 290401 - aço inox



Fabricado no Brasil

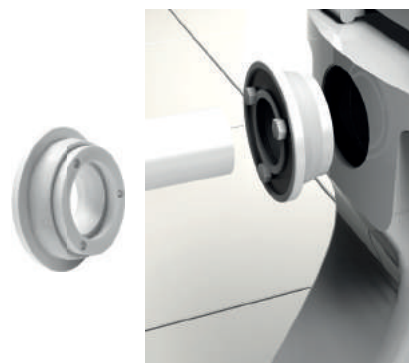

Espude de Vedação com Parafuso

PARA TUBO DE LIGAÇÃO
Plásticos de engenharia

Diâmetro externo: 81,2mm
Diâmetro interno: 35mm
Altura: 31mm

Ref. 290412



Fabricado no Brasil

ANÉIS DE VEDAÇÃO

A QUALIDADE QUE VOCÊ MERECE

NOVA FÓRMULA
NOVA EMBALAGEM
NÃO RESSECA



Anel de Vedação

Borracha butílica
PARA VASO SANITÁRIO SEM GUIA

Ref. 340101



Fabricado no Brasil



Anel de Vedação

Borracha butílica e plásticos de engenharia
PARA VASO SANITÁRIO COM GUIA

Ref. 340102 (+VENDIDO)



Fabricado no Brasil



nº 1 em Vendas



Kit Anel de Vedação

Borracha butílica e plásticos de engenharia
PARA INSTALAÇÃO DE VASO SANITÁRIO

Acompanha:
Kit para fixação em aço zincado.

Ref. 292509



Fabricado no Brasil

LIGAÇÕES FLEXÍVEIS



Ligação Flexível para Água

Liga de Cobre, Elastômeros e Aço Inoxidável AISI 304

Passagem interna: 8 mm
Pressão máxima: 40 m.c.a.
Rosca: 1/2 (M) x 1/2 (F)
Temperatura máxima: 80 °C



Ref. 250110 - compr. 20 cm
Ref. 250101 - compr. 30 cm **(+VENDIDO)**
Ref. 250102 - compr. 40 cm **(+VENDIDO)**
Ref. 250137 - compr. 50 cm
Ref. 250108 - compr. 60 cm **(+VENDIDO)**
Ref. 250120 - compr. 80 cm
Ref. 250116 - compr. 1,0 m
Ref. 250118 - compr. 1,2 m



Ligação Flexível para Água

Liga de Cobre, Elastômeros e Aço Inoxidável AISI 304

Passagem interna: 8 mm
Pressão máxima: 40 m.c.a.
Rosca: 1/2 (F) x 1/2 (F)
Temperatura máxima: 80 °C



Ref. 250220 - compr. 30 cm
Ref. 250203 - compr. 40 cm
Ref. 250208 - compr. 60 cm



Ligação Flexível para Água

PVC com poliéster trançado

Acabamento Branco
Passagem interna: 8 mm
Pressão máxima: 40 m.c.a.
Rosca: 1/2 (M) x 1/2 (F)
Somente para água fria

Ref. 251929 - compr. 30 cm
Ref. 251930 - compr. 40 cm **(+VENDIDO)**
Ref. 251931 - compr. 60 cm

Consulte outros comprimentos de 3,0M até 5,0M
Ver catálogo completo de produtos.



Ligação Flexível para Água

COM MAIOR VAZÃO

Liga de Cobre, Elastômeros e Aço Inoxidável AISI 304

Passagem interna: 10 mm
Pressão máxima: 40 m.c.a.
Rosca: 1/2 (M) x 1/2 (F)
Temperatura máxima: 80 °C



Bitola: 1/2 (M) x 1/2 (F)
Ref. 251104 - compr. 40 cm

Bitola: 1/2 (M) x 3/4 (F)
Ref. 250142 - compr. 40 cm



Ligação Flexível

PARA AQUECEDORES DE PASSAGEM

Liga de Cobre, Elastômeros e Aço Inoxidável AISI 304

Passagem interna: 15 mm
Pressão máxima: 40 m.c.a.
Rosca: 1/2 (M) x 1/2 (F)
Temperatura máxima: 80 °C



Ref. 250115 - compr. 30 cm
Ref. 250138 - compr. 40 cm



Ligação Flexível para Água

COM REGISTRO DE ESFERA INTEGRADO

Liga de Cobre, Elastômeros e Aço Inoxidável AISI 304

Passagem interna: 8 mm
Pressão máxima: 40 m.c.a.
Rosca: 1/2 (M) x 1/2 (F)
Temperatura máxima: 80 °C



Ref. 250131 - compr. 30 cm
Ref. 250146 - compr. 40 cm
Ref. 250133 - compr. 90 cm

Consulte outros comprimentos de 3,0M até 5,0M
Ver catálogo completo de produtos.



Kit Ligação Flexível

MISTURADOR MONOCOMANDO

Passagem interna: 8 mm
Pressão máxima: 40 m.c.a.
Rosca: M10 (M) x 1/2 (F)
Temperatura máxima: 70 °C



Ref. 251011 - compr. 40 cm
Ref. 251016 - compr. 60 cm



Kit Ligação Flexível

MISTURADOR MONOCOMANDO

Passagem interna: 8 mm
Pressão máxima: 40 m.c.a.
Rosca: M10 (M) x 1/2 (F)
Temperatura máxima: 80 °C



Ref. 251003 - compr. 40 cm
Ref. 251004 - compr. 60 cm



Ligação Flexível

MISTURADOR MONOCOMANDO

TERMINAL LONGO

Passagem interna: 8 mm
Pressão máxima: 40 m.c.a.
Rosca: M10 (M) x 1/2 (F)
Temperatura máxima: 70 °C

Ref. 251012 - compr. 40 cm
Ref. 251014 - compr. 60 cm



Ligação Flexível

MISTURADOR MONOCOMANDO

TERMINAL CURTO

Passagem interna: 8 mm
Pressão máxima: 40 m.c.a.
Rosca: M10 (M) x 1/2 (F)
Temperatura máxima: 70 °C

Ref. 251013 - compr. 40 cm
Ref. 251015 - compr. 60 cm



Conversor de Ligação Flexível

PARA MISTURADOR MONOCOMANDO

Pressão máxima: 40 m.c.a.
Temperatura máxima: 80 °C

Ref. 250701 - bitola M10 x M12
Ref. 250703 - bitola M10 x M10
Ref. 250704 - bitola M10 x M8



Vedante

LIGAÇÕES FLEXÍVEIS PARA ÁGUA

Elastômero | NBR

Ø externo: 19 mm / Ø interno: 10 mm
 Aplicação: Ligações flexíveis de 1/2
 Espessura: 2 mm

Ref. 101705

Ø externo: 25 mm / Ø interno: 16 mm
 Aplicação: Ligações flexíveis de 3/4
 Espessura: 3 mm

Ref. 101706



Vedante

LIGAÇÕES FLEXÍVEIS PARA ÁGUA COM FILTRO TIPO TELA DE AÇO INOXIDÁVEL



Elastômero | NBR

Ø externo: 19 mm / Ø interno: 10 mm
 Aplicação: Ligações de 1/2
 Espessura: 2,5 mm

Ref. 101708



Filtro para Misturadores e Torneiras

Poliacetil

Bitola: 1/2
 Rosca: macho x fêmea
 Sugestão de instalação:
 em misturadores monocomando



Ref. 310115 - com filtro removível
 Ref. 310116 - adaptador

MECANISMOS DE DESCARGA



somente o REPARO
 Ref. 340276



somente o CABEÇOTE
 Ref. 340202
 ou VEDAÇÕES
 Ref. 340289
 mecanismo COMPLETO COM BOIA
 Ref. 340221



VARETA EM AÇO INOXIDÁVEL

Mecanismo de Entrada

UNIVERSAL PARA CAIXA ACOPLADA



Plásticos de Engenharia e elastômeros
 Ciclos: 15.000
 Classe de pressão: 1 a 75 m.c.a.
 Nível de água: 135 mm a 280 mm

Ref. 340204 (+VENDIDO)



Mecanismo de Entrada

UNIVERSAL PARA CAIXA ACOPLADA

Plásticos de Engenharia e elastômeros
 Ciclos: 15.000
 Classe de pressão: 1 a 75 m.c.a.
 Nível de água: 210 mm a 300 mm
 Modelo: **Astra**

Ref. 340264 - sem boia
 Ref. 340253 - somente a boia



Mecanismo de Entrada

UNIVERSAL PARA CAIXA ACOPLADA

Plásticos de Engenharia, aço inoxidável e elastômeros
 Ciclos: 15.000
 Classe de pressão: 1 a 75 m.c.a.
 Nível de água: 145 mm a 290 mm

Ref. 340288



compatível com o castelo **ASTRA**
 Ref. 340201

Mecanismo de Saída

UNIVERSAL PARA CAIXA ACOPLADA



Plásticos de Engenharia e elastômeros
 Ciclos: 15.000

Ref. 340205 (+VENDIDO)



somente o **OBTURADOR**
 Ref. 340210

Mecanismo de Saída

PARA CAIXA ACOPLADA COM ACIONAMENTO SUPERIOR



Plásticos de Engenharia e elastômeros
 Ciclos: 15.000
 Modelo: **Astra, Blukit e similares**

Ref. 340274 (+VENDIDO)

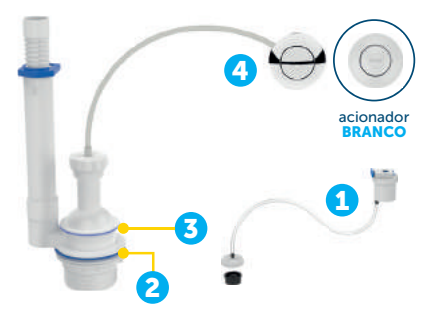

acionador **BRANCO**

Mecanismo de Saída

UNIVERSAL PARA CAIXA ACOPLADA COM ACIONAMENTO **PNEUMÁTICO**



Plásticos de Engenharia e elastômeros
 Ciclos: 15.000

Ref. 340214 - com botão cromado
 Ref. 340509 - com botão branco

- 1 Ref. 340254 - somente o acionador pneumático
- 2 Ref. 101730 - somente vedação da caixa
- 3 Ref. 101733 - membrana de vedação do mecanismo
- 4 Ref. 340503 - somente botão acionador cromado (sobressalente, não é rente a louça)

MECANISMOS DE DESCARGA



Mecanismo de Saída

PARA CAIXA ACOPLADA DE 3" (MAIOR DIÂMETRO)

Plásticos de Engenharia e elastômeros

Ciclos: 15.000

Modelo: **Celite Stylus** entre outros

Ref. 340506



Mecanismo de Saída

PARA CAIXA ACOPLADA **MONOBLOCO COM ACIONAMENTO PNEUMÁTICO**

Plásticos de Engenharia e elastômeros

Ciclos: 15.000

Ref. 340233



Mecanismo de Saída

PARA CAIXA ACOPLADA COM **DUPLO ACIONAMENTO UNIVERSAL**

Plásticos de Engenharia e elastômeros

Ciclos: 15.000

Ref. 340515
Ref. 101733 - somente membrana de vedação
Ref. 340282 - somente o acionador

ECONOMIZE ATÉ **50%**



Mecanismo de Saída

PARA CAIXA ACOPLADA COM **DUPLO ACIONAMENTO SUPERIOR**

Plásticos de Engenharia e elastômeros

Ciclos: 15.000

Ref. 340516

ECONOMIZE ATÉ **50%**

KITS PARA CAIXA ACOPLADA



Kit Completo

PARA CAIXA ACOPLADA COM ACIONADOR SUPERIOR

Plásticos de Engenharia e elastômeros

Ciclos: 15.000

340215 - branco **(+VENDIDO)**
340285 - cromado

1
nº 1 em Vendas

Fabricado no Brasil



Kit Completo

PARA CAIXA ACOPLADA COM ACIONADOR SUPERIOR

Plásticos de Engenharia e elastômeros

Ciclos: 15.000

340299 - branco **(+VENDIDO)**
340296 - cromado

Fabricado no Brasil



Kit Completo

PARA CAIXA ACOPLADA COM ACIONADOR SUPERIOR

Plásticos de Engenharia e elastômeros

Ciclos: 15.000

340272 - branco

Fabricado no Brasil



Kit Completo

Acompanha mecanismo de entrada e saída, kit de vedação e fixação, acionador **SUPERIOR BRANCO**.
Plásticos de Engenharia e elastômeros

Ref. 340241 **(+VENDIDO)**

Fabricado no Brasil



Kit Completo

Acompanha mecanismo de entrada e saída, kit de vedação e fixação, acionador **SUPERIOR BRANCO**.
Plásticos de Engenharia e elastômeros

Ref. 340292 **(+VENDIDO)**

Fabricado no Brasil



Kit Completo

Acompanha mecanismo de entrada e saída, kit de vedação e fixação, acionador **LATERAL**
Plásticos de Engenharia e elastômeros



Ref. 340216 - acionador branco
Ref. 340286 - acionador cromado



Kit Completo

Acompanha mecanismo de entrada e saída, kit de vedação e fixação, acionador **LATERAL**
Plásticos de Engenharia e elastômeros



Ref. 340502 - acionador branco
Ref. 340297 - acionador cromado



Kit Completo

Acompanha mecanismo de entrada e saída, kit de vedação e fixação, acionador **FRONTAL**
Plásticos de Engenharia e elastômeros



Ref. 340217 - acionador branco
Ref. 340287 - acionador cromado



Kit Completo

Acompanha mecanismo de entrada e saída, kit de vedação e fixação, acionador **FRONTAL**
Plásticos de Engenharia e elastômeros



Ref. 340501 - acionador branco



Kit Completo

Acompanha mecanismo de entrada e saída com acionador **PNEUMÁTICO UNIVERSAL**, kit de vedação e fixação
Plásticos de Engenharia e elastômeros



Ref. 340510 - branco **(+VENDIDO)**
Ref. 340218 - cromado



Kit Completo

Acompanha mecanismo de entrada e saída com acionador **PNEUMÁTICO UNIVERSAL**, kit de vedação e fixação
Plásticos de Engenharia e elastômeros



Ref. 340511 - branco **(+VENDIDO)**
Ref. 340293 - cromado



Botão compatível em qualquer posição

Ref. 340503

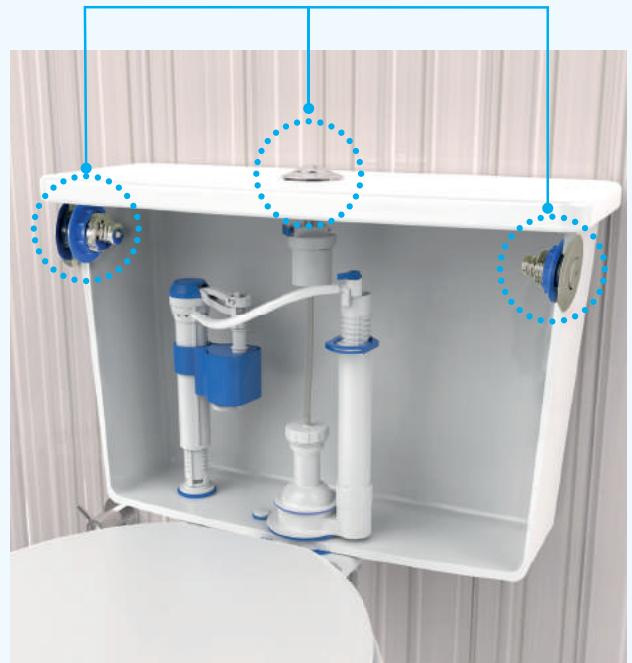

KITS PARA CAIXA ACOPLADA (Economia de Água)



Kit Completo

Acompanha mecanismo de entrada e saída com acionador **DUPLO UNIVERSAL CROMADO**, kit de vedação e fixação **Plásticos de Engenharia e elastômeros**



Ref. 340229



Kit Completo

Acompanha mecanismo de entrada e saída com acionador **DUPLO UNIVERSAL CROMADO**, kit de vedação e fixação **Plásticos de Engenharia e elastômeros**



Ref. 340294

MECANISMOS DE DESCARGA (Acessórios)



Acionador Superior

DUPLO PARA CAIXA ACOPLADA

Plásticos de Engenharia e elastômeros

Instalação: furo máximo de 52 mm
Modelo: **Roca, Celite, Incepa, Logasa e Astra antigo**

Ref. 340231 - cromado



Acionador Superior

DUPLO PARA CAIXA ACOPLADA

Plásticos de Engenharia e elastômeros

Instalação: furo máximo de 70 mm
Modelo: **Enternit e outros**

Ref. 340235 - cromado



Acionador Frontal

PARA CAIXA ACOPLADA

Plásticos de engenharia

Instalação: furo de $\varnothing 15$ mm a 28 mm
*acompanha corrente plástica

Ref. 340207 - cromado
Ref. 340255 - branco



Acionador Duplo

PARA CAIXA ACOPLADA

Plásticos de Engenharia e aço inoxidável

Ref. 340282 - cromado



Acionador Lateral

PARA CAIXA ACOPLADA

Plásticos de Engenharia, aço inoxidável e elastômeros

Instalação: furo de $\varnothing 10$ mm a 26 mm
*acompanha corrente plástica

Ref. 340212 - cromado **(+VENDIDO)**
Ref. 340263 - branco



Acionador Superior

PARA CAIXA ACOPLADA

Plásticos de Engenharia, aço inoxidável e elastômero

Instalação: furo de $\varnothing 38$ mm a 60 mm

Ref. 340211 - cromado **(+VENDIDO)**
Ref. 340222 - branco



2 EM 1



Acionador Superior

PARA CAIXA ACOPLADA

Plásticos de Engenharia, aço inoxidável e elastômeros

Instalação: furo de $\varnothing 32$ mm a 64 mm
*acompanha corrente plástica

Ref. 340213 - cromado **(+VENDIDO)**
Ref. 340256 - branco



ACESSIBILIDADE



Acionador Superior

SOBRESSALENTE PARA CAIXA ACOPLADA

Plásticos de engenharia

Instalação: furo de $\varnothing 38$ mm a 60 mm
*acompanha corrente plástica e canopla

Ref. 340278 - branco



Castelo para Mecanismo Convencional

PARA CAIXA ACOPLADA

Plásticos de engenharia

Modelo: **Astra**

Utilização mecanismos de saída **Astra** e **Blukit**
*acompanha corrente de acionamento

Ref. 340201





Obturador

UNIVERSAL PARA MECANISMO DE SAÍDA COM CORRENTE

Elastômeros e plásticos de engenharia

Ref. 340210 - com corrente **(+VENDIDO)**
 Ref. 340291 - sem corrente
 Ref. 340281 - somente corrente



Corte se necessário



Obturador com Vedação em Silicone

PARA MECANISMO DE SAÍDA COM REGULAGEM DE VAZÃO E COM CORRENTE

Compatível com **Astra e Blukit**

Elastômeros e Plásticos de engenharia

Ref. 340283



Corte se necessário



Vedação (bolsa)

PARA MECANISMO DE SAÍDA

Elastômeros

3 polegadas - Ref. 340508



Kit Parafuso Fixador

PARA CAIXA ACOPLADA

Plásticos de engenharia e elastômeros

Rosca: M10 x 80 mm



Ref. 340206 **(+VENDIDO)**



Vedação de Saída

PARA CAIXA ACOPLADA

Elastômeros

Ref. 340203



Kit Completo

UNIVERSAL PARA VEDAÇÃO E FIXAÇÃO DE CAIXA ACOPLADA

Plásticos de engenharia e elastômeros

Ref. 340220



Kit Parafuso Fixador

LATERAL PARA VASO SANITÁRIO

Aço inoxidável AISI 304 e plásticos de engenharia

A - Comprimento 65mm e rosca soberba Ø 5,8 mm
B - Comprimento 60mm e rosca soberba Ø 4,7 mm
 Bucha: nº 10

Modelo: **Cubo Duomo Deca, Monte Carlo e Vogue**

Ref. 100552



Aço Inoxidável



Kit Parafuso Fixador

EM AÇO ZINCADO PARA LAVATÓRIO, VASO SANITÁRIO E TANQUES

Aplicação: Lavatório

Bucha: nº 8 | Rosca: 7/32 x 80 mm
 Ref. 100560

Aplicação: Vaso sanitário

Bucha: nº 10 | Rosca: 1/4 x 90 mm
 Ref. 100562 **(+VENDIDO)**

Aplicação: Tanque

Bucha: nº 12 | Rosca: 3/8 x 100 mm
 Ref. 100563



Aço Inoxidável



Kit Parafuso Fixador

PARA LAVATÓRIO E VASO SANITÁRIO

Liga de cobre

Aplicação: Lavatório

Bucha: nº 8 | Rosca: 7/32 x 70 mm
 Ref. 100542

Aplicação: Vaso sanitário

Bucha: nº 10 | Rosca: 1/4 x 80 mm
 Ref. 100544 **(+VENDIDO)**

BORRACHA MACIA EVITA ARRANHAR



Kit Parafuso Fixador

PARA CAIXA ACOPLADA E ASSENTOS SANITÁRIOS

Aço inoxidável AISI 304 e elastômero

Rosca: M6
 Comprimento: 74 mm

Ref. 100561



Aço Inoxidável



Kit Parafuso Fixador

PARA VASO SANITÁRIO E BIDÊ

Aço inoxidável AISI 304 e elastômero

Rosca: M8
 Comprimento: 90 mm
 Bucha nº 10

Ref. 100551



Aço Inoxidável



VÁLVULAS DE DESCARGA

Reparos para válvulas de descarga modelo: **DOCOL RI-484 de 1.1/2**



Válvula de 1.1/2: baixa pressão
Classe de pressão: 1,5 a 15 m.c.a.

- 1 - Capa em ABS cromado
- 2 - Parafuso em aço inoxidável
- 3 - Canopla em ABS cromado
- 4 - Tecla em ABS cromado
- 5 - Parafuso regulador em aço inoxidável
- 6 - Porca sextavada em liga de cobre níquelada
- 7 - Trava em POM
- 8 - Mola em aço inoxidável
- 9 - Bucha em POM
- 10 - Retentor NBR
- 11 - Tampa em liga de cobre
- 12 - Anel o'ring NBR
- 13 - Sede em POM
- 14 - Anel o'ring NBR
- 15 - Anel trava em bronze
- 16 - Pistão
- 17 - Eixo em liga de cobre cromado
- 18 - Anel o'ring NBR
- 19 - Arruela em POM
- 20 - Contra sede em POM

Reparos para válvulas de descarga modelo: **HIDRA MAX de 1.1/2 e 1.1/4**

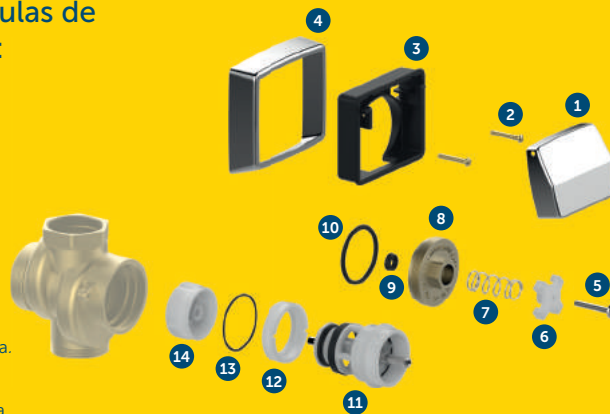

Válvula de 1.1/4: alta pressão
Classe de pressão: 6 a 40 m.c.a.

Válvula de 1.1/2: baixa pressão
Classe de pressão: 2 a 10 m.c.a.

- 1 - Tecla em ABS cromado
- 2 - Parafuso em liga de cobre
- 3 - Suporte ABS preto
- 4 - Canopla em ABS cromado
- 5 - Parafuso em liga de cobre níquelado
- 6 - Cruzeta em POM
- 7 - Mola de aço inoxidável
- 8 - Tampa em liga de cobre
- 9 - Retentor em NBR
- 10 - Anel o'ring NBR
- 11 - Pistão
- 12 - Sede em POM
- 13 - Anel o'ring NBR
- 14 - Contra sede em POM



Kit de Ferramentas

PARA VÁLVULA DE DESCARGA **DOCOL, HYDRA MAX e HYDRA LUXO/MASTER 1.1/4 e 1.1/2**

Liga de cobre, Plásticos de engenharia

Ref. 329401



Converter de Válvula de Descarga para Caixa Acoplada

Plásticos de Engenharia e Elastômeros
Conversão: DN38 para 1/2
Pressão máxima: 40 m.c.a.

Ref. 340365 - cromado - kit completo
Ref. 340366 - branco - kit completo
Ref. 340362 - cromado - somente conversor
Ref. 340364 - branco - somente conversor

Fabricado no Brasil

LANÇAMENTO



Acabamento

PARA VÁLVULA DE DESCARGA **HYDRA MAX**

Ref. 340310 - cromado **(+VENDIDO)**
Ref. 340350 - bege
Ref. 340351 - branco **(+VENDIDO)**
Ref. 340368 - preto

1
nº 1 em Vendas

Fabricado no Brasil



Tecla

PARA VÁLVULA DE DESCARGA **HYDRA MAX**

Ref. 340322 - cromado

Fabricado no Brasil



1
nº 1 em Vendas

Fabricado no Brasil

Kit de Reparo

PARA VÁLVULA DE DESCARGA **HYDRA MAX 2550**

* Mola / Retentor / Anel o'ring / Pistão

Plásticos de engenharia, liga de cobre, aço inoxidável e elastômeros

Ref. 349404 - sem cruzeta **(+VENDIDO)**
Ref. 349406 - com cruzeta



Fabricado no Brasil

Contra Sede

PARA VÁLVULA DE DESCARGA **HYDRA MAX**

Plásticos de engenharia

Ref. 349407 **(+VENDIDO)**



Fabricado no Brasil

Sede

PARA VÁLVULA DE DESCARGA **HYDRA MAX**

Bitola: 11/2 - 11/4
Alta e baixa pressão

Ref. 349408 - plástico



Fabricado no Brasil

Cruzeta

PARA VÁLVULA DE DESCARGA **HYDRA MAX - 1.1/2 e 1.1/4**

* Parafuso / Cruzeta / Mola

Ref. 349401
Ref. 349438 - somente cruzeta



Retentor

PARA VÁLVULA DE DESCARGA
HYDRA MAX e LISA II

Ref. 349403 (+VENDIDO)



Tampa

PARA VÁLVULA DE DESCARGA
HYDRA MAX - 1.1/2 e 1.1/4

Ref. 349402



Kit Fixador e Acionador

PARA VÁLVULA DE DESCARGA
HYDRA MAX/LUXO/MASTER

Liga de cobre

Ref. 340405 - compr. 40 mm
Ref. 340406 - compr. 70 mm



Acionador

PARA VÁLVULA DE DESCARGA
HYDRA MAX/LUXO/MASTER

Liga de cobre

Rosca: M5

Ref. 340407 - compr. 45 mm
Ref. 340408 - compr. 80 mm

LANÇAMENTO



Acabamento

PARA VÁLVULA DE DESCARGA
HYDRA LUXO/MASTER

Ref. 340309 - cromado (+VENDIDO)
Ref. 340356 - bege
Ref. 340358 - branco (+VENDIDO)
Ref. 340357 - cinza
Ref. 340370 - preto



Kit Reparo

PARA VÁLVULA DE DESCARGA
HYDRA LUXO/MASTER 2520 - 2530
** Vedante para tampa / Mola invertida / Vedante
guarnição / Vedante*

Ref. 349411 - 1 1/2
Ref. 349417 - 1 1/4



Kit de Reparo

PARA VÁLVULA DE DESCARGA
HYDRA LUXO/MASTER

Ref. 349412 - 1 1/2
Ref. 349418 - 1 1/4



COMPLETO



Kit Reparo e Acionador

PARA VÁLVULA DE DESCARGA
HYDRA LUXO/MASTER
** Bucha / Parafuso / Porca / Mola / Anel trava / Anel o'ring
Vedantes*

Ref. 349454 - 1 1/4
Ref. 349455 - 1 1/2



Acionador

PARA VÁLVULA DE DESCARGA
HYDRA LUXO/MASTER
** Parafuso / Porca / Mola / Anel trava / Anel o'ring*

Ref. 349414 (+VENDIDO)



Contra Sede

PARA VÁLVULA DE DESCARGA
HYDRA LUXO/MASTER

Ref. 349421 - 1 1/4
Ref. 349420 - 1 1/2



Sede

PARA VÁLVULA DE DESCARGA
HYDRA LUXO/MASTER

Bitola: 1 1/2
Alta e baixa pressão
Ref. 349446 - liga de cobre
Baixa pressão
Ref. 349484 - plástico

Bitola: 1 1/4
Alta e baixa pressão
Ref. 349422 - liga de cobre
Baixa pressão
Ref. 349483 - plástico



Êmbolo

PARA VÁLVULA DE DESCARGA
HYDRA LUXO/MASTER

Ref. 349413 - 1 1/2
Ref. 349419 - 1 1/4



Tampa

PARA VÁLVULA DE DESCARGA
HYDRA LUXO/MASTER
** Parafuso / Porca / Mola / Anel trava / Anel o'ring*

Ref. 349444 - 1 1/2



Eixo Regulador

PARA VÁLVULA DE DESCARGA
HYDRA LUXO/MASTER
** Parafuso / Porca / Mola / Anel trava / Anel o'ring*

Ref. 349409 - 1 1/2



Acabamento 7 em 1

PARA VÁLVULA DE DESCARGA **DECA
ANTIGA, LISA I, TINCO, HAMICO,
MADUTE, ORIENTE e METRILLA**

Ref. 340306 - cromado



Kit de Reparo

UNIFICADO **8 EM 1**
** Mola / Anel o'ring / Anel / Mola / Vedantes*

Modelo: **VCE** (2516 e 2517), **VCR** (2511)
e **Lisa I** (2515) de 1 1/2 e 1 1/4

Ref. 349453 (+VENDIDO)

VÁLVULAS DE DESCARGA



Fabricado no Brasil

Parafuso Injetor

PARA VÁLVULA DE DESCARGA
HYDRA VCR

Ref. 349423



Fabricado no Brasil

Kit de Reparo

PARA VÁLVULA DE DESCARGA
DECA ANTIGO 2510 DE 1 1/2 E 1 1/4

* Mola / Anel o'ring / Vedante / Mola invertida

Ref. 349436



Fabricado no Brasil

Êmbolo

PARA VÁLVULA DE DESCARGA

Ref. 349435 - Deca Antiga 1.1/2 e 1.1/4 (2510)

Ref. 349432 - Deca Antiga, Lisa I, Tingo, Hamico, Madute e Metrilla



Fabricado no Brasil

Acabamento

PARA VÁLVULA DE DESCARGA
HYDRA LISA II

Ref. 340337 - cromado



Fabricado no Brasil

Kit de Reparo

PARA VÁLVULA DE DESCARGA
HYDRA LISA II

* Porca / Retentor / Vedante / Anel o'ring / Eixo / Porca / Corpo do êmbolo / Mola

Ref. 349437

LANÇAMENTO



Fabricado no Brasil

Acabamento

PARA VÁLVULA DE DESCARGA
DOCOL

Ref. 340307 - crom, preto **(+VENDIDO)**

Ref. 340308 - cromado **(+VENDIDO)**

Ref. 340344 - bege

Ref. 340348 - branco **(+VENDIDO)**

Ref. 340371 - preto



Fabricado no Brasil

Tecla

PARA VÁLVULA DE DESCARGA
DOCOL

Ref. 340326 - preto

Ref. 340325 - cromado

Ref. 340345 - bege

Ref. 340349 - branco



Fabricado no Brasil

Kit de Reparo

PARA VÁLVULA DE DESCARGA
DOCOL

* Parafuso regulador / Porca sextavada / Trava / Mola / Bucha / Retentor / Sede / Anel o'ring / Anel trava / Pistão / Eixo / Arruela

Ref. 341601 - 1.1/2 **(+VENDIDO)**

Ref. 341602 - 1.1/4



Fabricado no Brasil

Kit de Reparo Completo

COM MOLA, TRAVA E PARAFUSO PARA VÁLVULA DE DESCARGA
DOCOL

* Parafuso regulador / Porca sextavada / Trava / Mola / Bucha / Retentor / Sede / Anel o'ring / Anel trava / Pistão / Eixo / Arruela / Êmbolo / Mola

Ref. 341613 - 1.1/2 **(+VENDIDO)**

Ref. 341612 - 1.1/4



Fabricado no Brasil

Kit de Reparo

PARA VÁLVULA DE DESCARGA
DOCOL RI 676 (ANTIGO)

* Parafuso / Porca sextavada / Trava / Mola / Porca castelo / Retentor / Anel o'ring / Anel trava / Pistão / Eixo / Arruela

Ref. 341626



Fabricado no Brasil

Kit de Vedantes

PARA VÁLVULA DE DESCARGA
DOCOL RI-484

* Bucha / Retentor / Anel o'ring / Anel trava

Ref. 341615 - Mod. 1.1/2

Ref. 341614 - Mod. 1.1/4



Fabricado no Brasil

Trava do Acionador

PARA VÁLVULA DE DESCARGA
DOCOL

* Trava / Mola

Plásticos de engenharia e Aço Inoxidável

Ref. 341608 - 1.1/2

Ref. 341607 - 1.1/4



Fabricado no Brasil

Contra Sede

PARA VÁLVULA DE DESCARGA
DOCOL

Ref. 341606 - 1.1/2

Ref. 341605 - 1.1/4



Fabricado no Brasil

Retentor

PARA VÁLVULA DE DESCARGA
DOCOL

Ref. 341619 - 1.1/2

Ref. 341618 - 1.1/4



Kit Vedante para Tampa Frontal

PARA VÁLVULA DE DESCARGA
DOCOL RI 484

Ref. 341623 - 1.1/2

Ref. 341624 - 1.1/4



Fabricado no Brasil

Tampa

PARA VÁLVULA DE DESCARGA
DOCOL

Ref. 341604 - 1.1/2

Ref. 341603 - 1.1/4



Fabricado no Brasil

Kit Fixador e Acionador

PARA VÁLVULA DE DESCARGA **DOCOL**

Liga de cobre
Rosca: M5

Ref. 340403 - compr. 45 mm
Ref. 340404 - compr. 80 mm



Fabricado no Brasil

Acionador

PARA VÁLVULA DE DESCARGA **DOCOL**

Liga de cobre
Rosca: M5

Ref. 340407 - compr. 45 mm
Ref. 340408 - compr. 80 mm



Fabricado no Brasil

Kit Parafuso Fixador

PARA VÁLVULA DE DESCARGA **DOCOL**

Aplicável também às marcas Hidra Max, Luxo e Master

Liga de cobre
Rosca: M5

Ref. 100526 - compr. 50 mm
Ref. 100524 - compr. 80 mm



Fabricado no Brasil

Acabamento

PARA VÁLVULA DE DESCARGA **CIPLA CD15**

Ref. 340312 - cromado/preto



Fabricado no Brasil

Kit de Reparo

PARA VÁLVULA DE DESCARGA **CIPLA CD15**

* Parafuso prisioneiro / Parafuso Vedante cor creme / Vedante cor preto

Ref. 349501



Fabricado no Brasil

Acabamento

PARA VÁLVULA DE DESCARGA **ORIENTE**

Ref. 340313 - cromado



Fabricado no Brasil

Acabamento 7 em 1

PARA VÁLVULA DE DESCARGA **ORIENTE**

Plásticos de engenharia

Ref. 340306 - cromado



Fabricado no Brasil

Kit de Reparo Unificado

6 EM 1 PARA VÁLVULA DE DESCARGA ORIENTE SUPER E PRIMOR
* Mola / Anel o'ring / Junta / Vedantes

Ref. 342135 **(+VENDIDO)**



Fabricado no Brasil

Kit de Reparo Unificado

PARA VÁLVULA DE DESCARGA **ORIENTE SUPER E PRIMOR**

* Mola / Anel o'ring / Junta / Vedantes

Ref. 342120



Fabricado no Brasil

Kit de Reparo

PARA VÁLVULA DE DESCARGA **ORIENTE PRIMOR 45mm** (até 1980 - 1981) com regulagem automática alta e baixa pressão
* Mola / Anel o'ring / Junta / Vedantes

Ref. 342119



Fabricado no Brasil

Acionador Completo

VÁLVULA DE DESCARGA **ORIENTE**

* Boião / Porca / Mola / Eixo / Bucha / Vedante / Porca

Ref. 342110 - Antigo (s/o'ring)
Ref. 342111 - Atual (c/ 'ring)



Fabricado no Brasil

Êmbolo

VÁLVULA DE DESCARGA **ORIENTE**

Ref. 342101 - 40 mm
Ref. 342102 - 45 mm



Fabricado no Brasil

Registro

P/ VÁLVULA DE DESCARGA **ORIENTE SUPER ANTIGO 1 1/2 e 1 1/4**

Ref. 342128



Fabricado no Brasil

Registro

PARA VÁLVULA DE DESCARGA **ORIENTE SUPER ATUAL 1 1/2 e 1 1/4**

Ref. 342129



Fabricado no Brasil

Kit Reparo Pistão

PARA VÁLVULA DE DESCARGA **FABRIMAR FLUX/TIGRE**

Liga de cobre, plástico de engenharia, aço inoxidável e elastômero

Ref. 342015

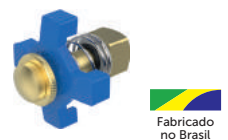

Fabricado no Brasil

Kit Reparo Haste

PARA VÁLVULA DE DESCARGA **FABRIMAR FLUX/TIGRE**

Liga de cobre, plástico de engenharia, aço inoxidável e elastômero

Ref. 342016

VÁLVULAS DE DESCARGA



Kit Reparo Registro

PARA VÁLVULA DE DESCARGA
FABRIMAR FLUX/TIGRE

Plástico de engenharia
e elastômero

Ref. 342017 - compr. 45 mm



Kit de Parafuso Fixador

PARA VÁLVULA DE DESCARGA
FABRIMAR

Liga de cobre

2 parafusos Rosca M4 x 58mm
1 parafuso Rosca M5 x 54mm

Ref. 342014



Acabamento

PARA VÁLVULA DE DESCARGA
LORENZETTI P-21, P-41, L20 E
FORTTI FT15

Ref. 340311 - cromado



Acabamento

PARA VÁLVULA DE DESCARGA
LORENZETTI P-20, BRONZE
DE 1 1/2 E 1 1/4

Ref. 340304



Kit de Reparo

PARA VÁLVULA DE DESCARGA
LORENZETTI

* Mola / Arruela / Redentor / Vedante / Porca

Ref. 344007 - P-20

Ref. 344011 - P-21

Ref. 344014 - P-41, L-20, FT-15



Kit de Reparo

COMPLETO **LORENZETTI**

Ref. 344026 - P-20

Ref. 344017 - P-21

Ref. 344013 - P-41 e FT-15



Tampa

PARA VÁLVULA DE DESCARGA
LORENZETTI 1.1/2

Ref. 344012 - P-20

Ref. 344027 - P-21



Tampa

PARA VÁLVULA DE DESCARGA
LORENZETTI e **FORTTI**

Ref. 344025 - FT 15, P-41 e L-20



Tampa e Eixo

PARA VÁLVULA DE DESCARGA
LORENZETTI 1.1/2

Ref. 344036 - P20



Copo

PARA VÁLVULA DE DESCARGA
LORENZETTI E **FORTTI** - P-21,
P-41, L-20, FT-15

344009 - 1.1/2

344008 - 1.1/2 (P21 base de bronze)



Acionador Completo

PARA VÁLVULA DE DESCARGA
LORENZETTI

* Botão / Porca / Mola / Eixo / Bucha / Vedante
/ Porca

Ref. 344022 - P20



Acionador Completo

PARA VÁLVULA DE DESCARGA
LORENZETTI

* Botão / Porca / Mola / Eixo / Bucha / Vedante
/ Porca

Ref. 344018 - P21



Kit de Reparo

PARA VÁLVULA DE DESCARGA
MODELO **ASTRA**

Aço Inoxidável, Liga de cobre,
Plásticos de engenharia

Ref. 349601



Kit de Reparo Completo

PARA VÁLVULA DE DESCARGA **ALBION/HAMICO/MADUTE**

* Mola p/acionador/Madute/Albion / Cring / Vedante c/rebaixo /Madute/Albion / Arruela p/tampa / Mola do êmbolo / Vedante/guarrição Madute / Vedante do êmbolo / Vedante p/parafuso injetor / Mola p/acionador Hamico / Vedante c/rebaixo Hamico / Arruela p/tampa mola do êmbolo / Vedante/guarrição Madute / Vedante p/acionador

Ref. 349701 - 1.1/2 e 1.1/4 unificado

Ref. 349711 - Madute

FITAS VEDA ROSCA

QUALIDADE SUPERIOR, MAIOR DURABILIDADE



Fita Veda Rosca Carretel

Politetrafluoretileno (PTFE)

Aplicação: Tubos e conexões para água quente ou fria, com roscas metálicas ou plásticas.

Ref. 102523 - 18 mm x 25 m

Ref. 102524 - 18 mm x 50 m



Fita Veda Rosca Caixa

Politetrafluoretileno (PTFE)

Aplicação: Tubos e conexões para água quente ou fria, com roscas metálicas ou plásticas.

Ref. 102515 - 12 mm x 5 m

Ref. 102516 - 18 mm x 5 m

Ref. 102517 - 12 mm x 10 m

Ref. 102518 - 12 mm x 25 m



Ref. 102519 - 18 mm x 10 m

Ref. 102520 - 18 mm x 25 m

Ref. 102521 - 18 mm x 50 m

Ref. 102522 - 12 mm x 50 m

Blukit Duchão



Torneiras e Chuveiros com

+ PRESSÃO + CONFORTO + ECONOMIA



3/4 1.1/2

Demais bitolas para adaptar:



Duchão Luva 3/4 x 1/2 Niple 1/2 Adaptador 1/2



Duchão Luva 3/4 x 1 Niple 1 Adaptador 1

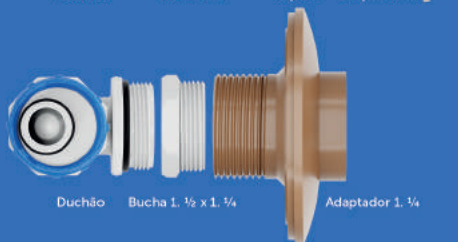

Duchão Bucha 1/2 x 1 1/4 Adaptador 1 1/4

Segurança necessária:



Regule a pressão em 40 m.c.a.

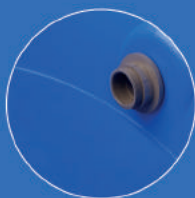

Instale Tubo Ladrão de 50 mm

Ref. 330601



TORNEIRAS DE BOIA

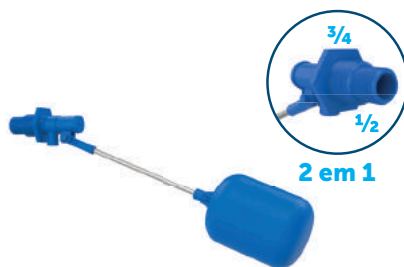

Torneira de Boia



MODELO NEO

Plásticos de engenharia e elastômero

Haste em Alumínio
 Pressão máxima: 75 m.c.a.
 Rosca: 1/2 (M) | 3/4 (M)
 Temperatura máxima: 45° C

Ref. 191417



Torneira de Boia



VAZÃO TOTAL

Plásticos de engenharia e elastômero

Haste em Liga de cobre
 Pressão máxima: 75 m.c.a.
 Rosca: 1/2 (M) | 3/4 (M)
 Temperatura máxima: 45° C

Ref. 191401 (+VENDIDO)



Torneira de Boia



VAZÃO TOTAL

Plásticos de engenharia e elastômero

Haste em Liga de cobre
 Pressão máxima: 75 m.c.a.
 Rosca: 1 polegada
 Temperatura máxima: 45° C

Ref. 191404

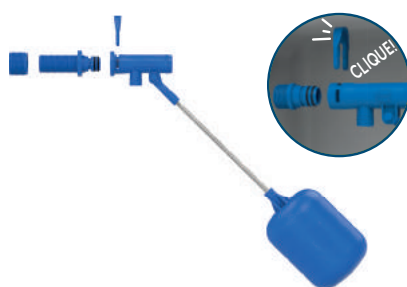

Torneira de Boia



COM ENGATE RÁPIDO

Plásticos de engenharia e elastômero

Haste em Alumínio
 Bucha de redução: 1/2 x 3/4
 Pressão máxima: 40 m.c.a.
 Rosca: 1/2 (M)
 Temperatura máxima: 45° C

Ref. 191409

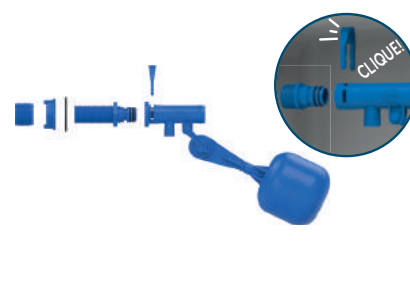

Torneira de Boia



PARA PEQUENOS RESERVATÓRIOS COM ENGATE RÁPIDO

Plásticos de engenharia e elastômero

Bucha de redução: 1/2 x 3/4
 Pressão máxima: 40 m.c.a.
 Rosca: 1/2 (M)
 Temperatura máxima: 45° C

Ref. 191411



Recomendamos a instalação de uma válvula redutora de pressão antes da caixa d'água (com ou sem manômetro)

Com manômetro 1/2 e 3/4
 Ref. 330311

Sem manômetro 1/2 e 3/4
 Ref. 330313

Encontre na página 61 deste guia



KIT DUCHA

+REGISTRO COM
DERIVAÇÃO

Blukit Confort



Kit Ducha Higiênica

Fabricado no Brasil

REGISTRO C/ DERIVAÇÃO
DUCHA TODA BRANCA

Bitola: 1/2
Comprimento: 1,2 m
Passagem interna: 6 mm
Pressão máxima: 40 m.c.a.
Temperatura máxima: 60 °C

Acompanha:

Ducha: Plástico de Engenharia
Registro c/ derivação: Plástico de Engenharia
Flexível: PVC

Ref. 221204



Kit Ducha Higiênica

Fabricado no Brasil

REGISTRO C/ DERIVAÇÃO
DUCHA BRANCA COM CRIVO CROMADO

Bitola: 1/2
Comprimento: 1,2 m
Passagem interna: 6 mm
Pressão máxima: 40 m.c.a.
Temperatura máxima: 60 °C

Acompanha:

Ducha: Plástico de Engenharia
Registro c/ derivação: Plástico de Engenharia
Flexível: Aço inoxidável

Ref. 220928



Kit Ducha Higiênica

Fabricado no Brasil

REGISTRO C/ DERIVAÇÃO
DUCHA TODA CROMADA MODELO LUXO

Bitola: 1/2
Comprimento: 1,2 m
Passagem interna: 6 mm
Pressão máxima: 40 m.c.a.
Temperatura máxima: 60 °C

Acompanha:

Ducha: Plástico de Engenharia
Registro c/ derivação: Plástico de Engenharia
Flexível: Aço inoxidável

Ref. 220929



Fabricado no Brasil

Kit Ducha Higiênica

REGISTRO CONFORT
DUCHA TODA BRANCA

Bitola: 1/2
Comprimento: 1,2 m
Passagem interna: 6 mm
Pressão máxima: 40 m.c.a.
Temperatura máxima: 60 °C

Acompanha:

Ducha: Plástico de Engenharia
Registro: Plástico de Engenharia
Flexível: PVC

Ref. 221205



Fabricado no Brasil

Kit Ducha Higiênica

REGISTRO CONFORT
DUCHA BRANCA COM
CRIVO CROMADO

Bitola: 1/2
Comprimento: 1,2 m
Passagem interna: 6 mm
Pressão máxima: 40 m.c.a.
Temperatura máxima: 60 °C

Acompanha:

Ducha: Plástico de Engenharia
Registro: Plástico de Engenharia
Flexível: Aço inoxidável

Ref. 220930 - cromado
Ref. 220939 - preto



Fabricado no Brasil

Kit Ducha Higiênica

REGISTRO CONFORT
DUCHA TODA CROMADA
MODELO LUXO

Bitola: 1/2
Comprimento: 1,2 m
Passagem interna: 6 mm
Pressão máxima: 40 m.c.a.
Temperatura máxima: 60 °C

Acompanha:

Ducha: Plástico de Engenharia
Registro: Plástico de Engenharia
Flexível: Aço inoxidável

Ref. 220931



Fabricado no Brasil

Kit Ducha Higiênica

MODELOS LUXO

Bitola: 1/2
Comprimento: 1,2 m
Passagem interna: 6 mm
Pressão máxima: 40 m.c.a.
Temperatura máxima: 60 °C

Acompanha:

Ducha: Plástico de Engenharia
Registro: Plástico de Engenharia
Flexível: Aço inoxidável

Ref. 220915 - branco
Ref. 220927 - cromado

KITS DUCHAS HIGIÊNICAS



Fabricado no Brasil

Kit Ducha Higiênica

TODA BRANCA

Bitola: 1/2
Comprimento: 1,2 m
Passagem interna: 6 mm
Pressão máxima: 40 m.c.a.
Temperatura máxima: 60 °C

Acompanha:
Ducha: Plástico de Engenharia
Registro 1/4 de volta: Plástico de Engenharia
Flexível: PVC

Ref. 221203



Fabricado no Brasil

Kit Ducha Higiênica

COM DUCHA BRANCA

Bitola: 1/2
Comprimento: 1,2 m
Passagem interna: 6 mm
Pressão máxima: 40 m.c.a.
Temperatura máxima: 60 °C

Acompanha:
Ducha: Plástico de Engenharia
Registro 1/4 de volta: Plástico de Engenharia
Flexível: Aço Inoxidável

Ref. 220910



Fabricado no Brasil

Kit Ducha Higiênica

COM CRIVO CROMADO

Bitola: 1/2
Comprimento: 1,2 m
Passagem interna: 6 mm
Pressão máxima: 40 m.c.a.
Temperatura máxima: 60 °C

Acompanha:
Ducha: Plástico de Engenharia
Registro 1/4 de volta: Plástico de Engenharia
Flexível: Aço inoxidável

Ref. 220911 (+VENDIDO)



Fabricado no Brasil

Kit Ducha Higiênica

MODELOS LUXOS

Bitola: 1/2
Comprimento: 1,2 m
Passagem interna: 6 mm
Pressão máxima: 40 m.c.a.
Temperatura máxima: 60 °C

Acompanha:
Ducha: Plástico de Engenharia
Registro 1/4 de volta: Plástico de Engenharia
Flexível: Aço inoxidável

Ref. 220926



ACOMPANHA PARAFUSO BUCHA E VEDANTE

Ducha Modelo Luxo

COM GATILHO E SUPORTE

Bitola: 1/2
Pressão máxima: 40 m.c.a.
Temperatura máxima: 60 °C
Plásticos de engenharia

Ref. 240101 - branco
Ref. 240102 - cromado



LANÇAMENTO

ACOMPANHA PARAFUSO BUCHA E VEDANTE

Ducha Modelo POP

COM GATILHO E SUPORTE TIPO GANCHO

Bitola: 1/2
Pressão máxima: 40 m.c.a.
Temperatura máxima: 60 °C
Plásticos de engenharia

Ref. 240203 - branco (+VENDIDO)
Ref. 240205 - cromado
Ref. 240202 - branco com crivo cromado
Ref. 240210 - preto com crivo cromado



IDEAL PARA HOTELARIA

ACOMPANHA PARAFUSO BUCHA E VEDANTE

Ducha Modelo POP

SEM GATILHO E COM SUPORTE TIPO GANCHO

Bitola: 1/2
Pressão máxima: 40 m.c.a.
Temperatura máxima: 60 °C
Plásticos de engenharia

Ref. 240204 - branco
Ref. 240207 - cromado





Ligação Flexível

CORRUGADA PARA DUCHAS

Aço Inoxidável

Passagem interna: 6 mm
Pressão máxima: 40 m.c.a.
Temperatura máxima: 60 °C
Rosca: 1/2 (F) x (F)

Ref. 210910 - compr. 1,2 m
(+VENDIDO)

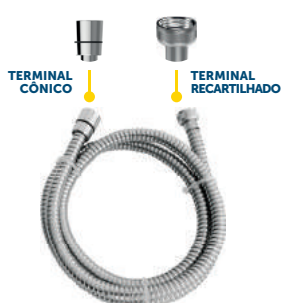

Ligação Flexível

CORRUGADA PARA DUCHAS

Aço Inoxidável

Passagem interna: 6 mm
Pressão máxima: 40 m.c.a.
Temperatura máxima: 60 °C
Rosca: 1/2 (F) x (F)

Ref. 210911 - compr. 1,2 m
(+VENDIDO)
Ref. 210913 - compr. 1,6 m
Ref. 210903 - compr. 1,8 m
Ref. 210912 - compr. 2,0 m

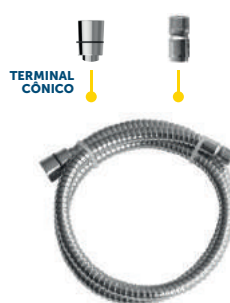

Ligação Flexível

PARA MISTURADOR MONOCOMANDO

Aço Inoxidável

Passagem interna: 6 mm
Pressão máxima: 40 m.c.a.
Temperatura máxima: 60 °C
Rosca: 1/2 (F) x M15 x 1 (M)

Ref. 191995 - compr. 1,5 m



Flexível para Duchas

MISTURADOR MONOCOMANDO

Passagem interna: 6 mm
Pressão máxima: 40 m.c.a.
Rosca: 1/2 (F) x 1/2 (F)
Temperatura máxima: 80 °C

Ref. 211205 - compr. 1,2 m
Ref. 211206 - compr. 1,8 m
Ref. 211202 - compr. 3 m



Registro

PARA DUCHA HIGIÊNICA COM VOLANTE CONFORT

Bitola: 1/2
Pressão máxima: 40 m.c.a.

Plásticos de engenharia

Ref. 200219 - branco
Ref. 200220 - cromado
Ref. 200222 - preto



Registro

PARA DUCHA HIGIÊNICA COM VOLANTE CONFORT COM DERIVAÇÃO

Bitola: 1/2
Pressão máxima: 40 m.c.a.

Plásticos de engenharia

Ref. 200217 - branco
Ref. 200218 - cromado



EVITE "GAMBIARRAS"



Registro

PARA DUCHA HIGIÊNICA COM VOLANTE C-25

Bitola: 1/2
Pressão máxima: 40 m.c.a.

Plásticos de engenharia

Ref. 200213 - branco (1/4 Volta)
Ref. 200206 - cromado (Rotativo)



Registro

PARA DUCHA MANUAL

Liga de cobre

Bitola: 1/2
Pressão de serviço: 40 m.c.a.
Rosca: macho x fêmea

Ref. 200221 - cromado



Suporte Quadrado

PARA DUCHAS HIGIÊNICAS
*bucha nº 06 e parafuso 4,2 x 38

Plásticos de engenharia

Parafusos em Aço Inoxidável AISI 304

Ref. 200104 - branco
Ref. 200101 - cromado



Suporte Tipo Gancho

PARA DUCHAS HIGIÊNICAS
*bucha nº 06 e parafuso 4,2 x 38

Plásticos de engenharia

Parafusos em Aço Inoxidável AISI 304

Ref. 200103 - branco
Ref. 200102 - cromado

ACESSÓRIOS PARA BANHEIRO



Kit de Acessórios para Banheiro

MODELO **NEO**

Plástico de engenharia e aço inoxidável AISI 304

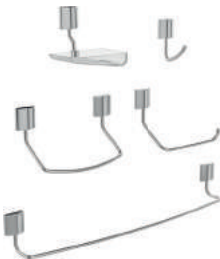

Fabricado no Brasil

Acompanha

- 1 Saboneteira de parede
- 1 Cabide multiuso
- 1 Papeleiro
- 1 Porta-toalhas
- 1 Porta-toalhas de 500 mm

Acessórios avulsos

- Ref. 290710 - Saboneteira de parede
- Ref. 290921 - Cabide multiuso
- Ref. 290823 - Papeleiro
- Ref. 291030 - Porta-toalhas
- Ref. 291031 - Porta-toalhas 500 mm

Ref. 291209



Kit Salva Registro

PARA DUCHAS E CHUVEIROS

Liga de cobre

Acabamento Cromado
Classe de pressão: 2 a 40 m.c.a.
Sistema MVC 1/4 de volta

Ref. 190606



Cruzeta Desviadora

PARA RESERVATÓRIO DE ÁGUA QUENTE COM SUPORTE

Liga de cobre

Acabamento Cromado
Classe de pressão: 2 a 40 m.c.a.

Tubo em liga de cobre

- Ref. 190603 - com MVC
- Ref. 190613 - com MVS

Tubo em CPVC

- Ref. 190615 - com MVC
- Ref. 190616 - com MVS



Cruzeta Desviadora

SEM TUBO

PARA RESERVATÓRIO DE ÁGUA QUENTE

Liga de cobre

Acabamento Cromado
Classe de pressão: 2 a 40 m.c.a.

- Ref. 190607 - com MVC
- Ref. 190619 - com MVS



Válvula

DESVIADORA PARA CHUVEIRO

Liga de cobre

Bitola: 1/2
Classe de pressão: 2 a 40 m.c.a.
Modelo: redondo
Rosca: macho x fêmea
Temperatura máxima: 60 °C

Ref. 191201 - cromado

LANÇAMENTO



Kit Ducha com Válvula

AISI 304 AÇO INOX

Aço Inoxidável

DESVIADORA PARA CHUVEIRO

Toda cromada

Bitola: 1/2
Comprimento: 1,8 m
Pressão máxima: 40 m.c.a.
Temperatura máxima: 60 °C

Acompanha

Ducha: Plástico de engenharia Flexível anti-torção:
Aço inoxidável de 1,8 m
Válvula desviadora: Liga de cobre

Ref. 191208 - cromado



Com ducha aberta



Com ducha fechada



Expositor de módulos



Gabarito de rosca do nº 0 ao 50



Banner passo a passo

Kit Completo para Registros de Pressão



MÓDULOS DE REDUÇÃO PARA REGISTRO DE PRESSÃO do nº 0 ao 50 com 3 peças de cada

KIT FÁCIL PARA REGISTRO DE PRESSÃO
20 peças / 060106

KIT FÁCIL PARA TORNEIRA
10 peças / 060207

CARRAPETA EM LIGA DE COBRE
5 peças / 060503
5 peças / 060504

1 expositor de módulos + banner / 101302

1 gabarito de rosca do nº 0 ao 50 / 320101

O kit acompanha:

- 01 Expositor
- 01 Gabarito de Roscas
- 01 Banner passo a passo
- 02 Tipos de Kit Fácil
- 02 Tipos de Carrapetas
- 50 Tipos de Módulos de Redução



Módulos de Redução

PARA REGISTRO DE PRESSÃO

Liga de cobre
Rosca: interna nº 0

- Ref. 060349 - rosca nº 0
- Ref. 060345 - rosca nº 1
- Ref. 060301 - rosca nº 2 **(+VENDIDO)**
- Ref. 060352 - rosca nº 2 **ALONGADO**
- Ref. 060302 - rosca nº 3
- Ref. 060303 - rosca nº 4
- Ref. 060304 - rosca nº 5
- Ref. 060305 - rosca nº 6 **(+VENDIDO)**
- Ref. 060306 - rosca nº 7 **(+VENDIDO)**
- Ref. 060307 - rosca nº 8
- Ref. 060308 - rosca nº 9
- Ref. 060309 - rosca nº 10
- Ref. 060310 - rosca nº 11
- Ref. 060311 - rosca nº 12
- Ref. 060312 - rosca nº 13
- Ref. 060313 - rosca nº 14
- Ref. 060314 - rosca nº 15

- Ref. 060315 - rosca nº 16
- Ref. 060316 - rosca nº 17
- Ref. 060317 - rosca nº 18
- Ref. 060318 - rosca nº 19
- Ref. 060319 - rosca nº 20
- Ref. 060320 - rosca nº 21
- Ref. 060321 - rosca nº 22
- Ref. 060322 - rosca nº 23
- Ref. 060323 - rosca nº 24
- Ref. 060324 - rosca nº 25
- Ref. 060325 - rosca nº 26
- Ref. 060326 - rosca nº 27
- Ref. 060327 - rosca nº 28
- Ref. 060328 - rosca nº 29
- Ref. 060329 - rosca nº 30
- Ref. 060330 - rosca nº 31
- Ref. 060331 - rosca nº 32

- Ref. 060332 - rosca nº 33
- Ref. 060347 - rosca nº 34
- Ref. 060348 - rosca nº 35
- Ref. 060333 - rosca nº 36
- Ref. 060334 - rosca nº 37
- Ref. 060335 - rosca nº 38
- Ref. 060336 - rosca nº 39
- Ref. 060337 - rosca nº 40
- Ref. 060338 - rosca nº 41
- Ref. 060339 - rosca nº 42
- Ref. 060340 - rosca nº 43
- Ref. 060350 - rosca nº 45 **(+VENDIDO)**
- Ref. 060351 - rosca nº 46
- Ref. 060341 - rosca nº 47
- Ref. 060342 - rosca nº 48
- Ref. 060343 - rosca nº 49
- Ref. 060344 - rosca nº 50

REGISTRO DE PRESSÃO



Kit Fácil®



PARA REGISTRO

Ciclos: 50.000
Comprimento do corpo: 46,5 mm
Comprimento da haste: 64 mm
 Estrias padrão **DECA** (A)
 O'ring Castelo: 100801

Haste cromada

Ref. 060162 - rosca nº 0
 Ref. 060164 - rosca nº 1
 Ref. 060176 - rosca nº 2

Haste sem cromagem

Ref. 060106 - rosca nº 0
(+VENDIDO)
 Ref. 060108 - rosca nº 1
 Ref. 060175 - rosca nº 2
 Ref. 060183 - rosca nº 3
 Ref. 060184 - rosca nº 4
 Ref. 060185 - rosca nº 5
 Ref. 060186 - rosca nº 6
 Ref. 060187 - rosca nº 7
 Ref. 060188 - rosca nº 8
 Ref. 060189 - rosca nº 9
 Ref. 060190 - rosca nº 10
 Ref. 060192 - rosca nº 12
 Ref. 060109 - rosca nº 34
 Ref. 060110 - rosca nº 35
 Ref. 060111 - rosca nº 45



Kit Fácil®



PARA REGISTRO

ADQUIRA ESSE ITEM QUANDO JÁ TIVER OS COMPLEMENTOS TELESCÓPICOS

Ciclos: 50.000
Comprimento do corpo: 46,5 mm
Comprimento da haste: 64 mm

SEM MÓDULOS TELESCÓPICOS

Estrias padrão **DECA** (A)
 O'ring Castelo: 100801

Ref. 060170 - rosca nº 0
(+VENDIDO)
 Ref. 060182 - rosca nº 1
 Ref. 061212 - rosca nº 2
 Ref. 061213 - rosca nº 3
 Ref. 061215 - rosca nº 5
 Ref. 061216 - rosca nº 6
 Ref. 061217 - rosca nº 7
 Ref. 061218 - rosca nº 8



Kit Fácil®



PARA REGISTRO

Acabamento **DECA DREAM/POLO**
Comprimento: 73 mm
 Ciclos: 50.000
 O'ring Castelo: 100801
 *acompanha conversor sem rosca

Ref. 061205 - rosca nº 0



Kit Fácil®



PARA REGISTRO

Ciclos: 50.000
 Estrias padrão **DOCOL** (B)
 O'ring Castelo: 100801

Ref. 060137 - rosca nº 0
 Ref. 060138 - rosca nº 1



Kit Fácil®



PARA REGISTRO

Ciclos: 50.000
 Estrias padrão **FABRIMAR** (C)
 O'ring Castelo: 100802

Ref. 060143 - rosca nº 0



Kit Fácil®



PARA REGISTRO

Plástico de engenharia reforçado, liga de cobre e elastômero
 Ciclos: 50.000
 Estrias padrão **DECA** (A)

Ref. 061407 - rosca nº 01
 Ref. 061409 - rosca nº 02
 Ref. 061410 - rosca nº 03
 Ref. 061411 - rosca nº 04
 Ref. 061412 - rosca nº 05
 Ref. 061413 - rosca nº 06
 Ref. 061414 - rosca nº 07
 Ref. 061415 - rosca nº 08
 Ref. 061416 - rosca nº 09
 Ref. 061405 - rosca nº 10
 Ref. 061408 - rosca nº 11
 Ref. 061406 - rosca nº 12
 Ref. 061417 - rosca nº 29
 Ref. 061418 - rosca nº 33
 Ref. 061419 - rosca nº 43
 Ref. 061404 - rosca nº 48



REGISTRO PARA TORNEIRAS



Kit Fácil®



PARA TORNEIRA

Liga de cobre
 Ciclos: 50.000
 Estrias padrão **DECA** (A)
 O'ring Castelo: 100801

Com Cruzeta

Ref. 060216 - rosca nº 0 (L)
 Ref. 060217 - rosca nº 1 (C)
 Ref. 060218 - rosca nº 2 (C)
 Ref. 060219 - rosca nº 3 (L)
 Ref. 060220 - rosca nº 4 (L)
 Ref. 060221 - rosca nº 5 (L)
 Ref. 060222 - rosca nº 6 (L)
 Ref. 060223 - rosca nº 7 (L)
 Ref. 060266 - rosca nº 33 (L)
 Ref. 060225 - rosca nº 34 (C)
 Ref. 060226 - rosca nº 35 (C)

LEGENDA: C (curto) L (longo)

Sem Cruzeta

Ref. 060227 - rosca nº 0 (L)
 Ref. 060228 - rosca nº 1 (C)
 Ref. 060229 - rosca nº 2 (C)
 Ref. 060230 - rosca nº 3 (L)
 Ref. 060236 - rosca nº 34 (C)



Kit Fácil®



PARA TORNEIRA

Plástico de engenharia reforçado, Liga de cobre e Elastômero
 Ciclos: 50.000
 Estrias padrão **DECA** (A)

Ref. 061501 - rosca nº 01
 Ref. 061502 - rosca nº 02
 Ref. 061503 - rosca nº 03
 Ref. 061504 - rosca nº 04
 Ref. 061505 - rosca nº 05
 Ref. 061506 - rosca nº 06
 Ref. 061507 - rosca nº 07
 Ref. 061508 - rosca nº 08
 Ref. 061509 - rosca nº 09
 Ref. 061510 - rosca nº 10
 Ref. 061511 - rosca nº 11
 Ref. 061512 - rosca nº 12





Kit Fácil®



PARA TORNEIRA

Liga de cobre

Ciclos: 50.000
Estrias padrão **DECA** (A)
O'ring Castelo: 100801

Haste cromada

Ref. 060259 - rosca nº 0 **(+VENDIDO)**
Ref. 060261 - rosca nº 1
Ref. 060281 - rosca nº 2

Haste sem cromagem

Ref. 060207 - rosca nº 0 **(+VENDIDO)**
Ref. 060209 - rosca nº 1
Ref. 060278 - rosca nº 2
Ref. 061305 - rosca nº 5
Ref. 061306 - rosca nº 6
Ref. 061307 - rosca nº 7
Ref. 061309 - rosca nº 9
Ref. 060290 - rosca nº 34

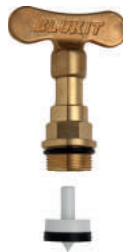

Kit Fácil®



PARA TORNEIRA

Liga de cobre

Ciclos: 50.000
Estrias padrão **DOCOL** e Similares
O'ring Castelo: 100801

Ref. 061014 - rosca nº 0 **(L)**
Ref. 061015 - rosca nº 1 **(C)**
Ref. 061016 - rosca nº 2 **(C)**
Ref. 061017 - rosca nº 3 **(L)**
Ref. 061025 - rosca nº 34 **(C)**

LEGENDA: C (curto) L (longo)



Kit Fácil®



PARA TORNEIRA

Liga de cobre

Ciclos: 50.000
Estrias padrão **DECA** (A)
O'ring Castelo: 100801

Haste cromada

Ref. 060285 - rosca nº 0
Ref. 060286 - rosca nº 1

Haste sem cromagem

Ref. 060288 - rosca nº 0
Ref. 060289 - rosca nº 1

KIT FÁCIL® - COMPLEMENTOS



Anéis O'ring



PARA REGISTROS DE PRESSÃO

Elastômeros

Kit de anéis O'ring
Ref. 100812

Ø Ext.: 19,5 mm / Ø Int.: 15,5 mm
Espessura: 2 mm
Aplica.: Mód. de redução (menor)

Ref. 100807

Ø Ext.: 24 mm / Ø Int.: 19 mm
Espessura: 2,5 mm
Aplica.: Mód. de redução (maior)

Ref. 100808

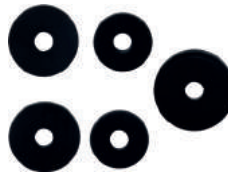

Kit de Vedantes



EM BORRACHA NITRÍLICA
PARA REGISTROS E TORNEIRAS

*acompanham 2 vedantes de 13 mm, 2 vedantes de 15 mm e 1 vedante de 18 mm

Ref. 060608 - Kit completo
Ref. 101734 - Kit completo **FABRIMAR**

Abaulado

Ref. 060607 - 1/2 (13 mm)
Ref. 060606 - 3/4 (15 mm) **(+VENDIDO)**

Reta

Ref. 060601 - 3/8 (11 mm)
Ref. 060602 - 1/2 (13 mm)
Ref. 060603 - 3/4 (15 mm) **(+VENDIDO)**
Ref. 060604 - 1 (18 mm) **(+VENDIDO)**
Ref. 060605 - 1 1/4 (22 mm)
Ref. 060609 - 1 1/2 (26 mm)



Carrapetas



PARA REGISTROS DE PRESSÃO
E TORNEIRAS (VEDAÇÃO)

Plásticos de engenharia e elastômeros

Kit (12,5-15,5-19,5 mm)
Ref. 060519

Ref. 060512 - 3/8 (12,5 mm)
Ref. 060513 - 1/2 (14,5 mm)
Ref. 060514 - 3/4 (15,5 mm)
Ref. 060515 - 1 (19,5 mm)



Carrapeta



COM VEDANTE ABAULADO

Liga de cobre e elastômeros

Ref. 060516 - 1/2 (13 mm)
Ref. 060505 - 3/4 (15 mm)

Aplica.: utilizado no Kit Fácil



Carrapeta em PPS



COM VEDANTE ABAULADO OU RETO

Plásticos de engenharia e elastômeros

Ref. 060521 - 15 mm - vedante abaulado
Ref. 060522 - 18 mm



Carrapeta



UNIVERSAL

Liga de cobre e elastômeros

Ref. 060501 - 1/2 (13 mm)
Ref. 060502 - 3/4 (15 mm)
Ref. 060503 - 1 (18 mm)
Ref. 060504 - 1 1/4 (22 mm)

KIT FÁCIL® - COMPLEMENTOS



Carrapeta

UNIVERSAL

Liga de cobre e elastômeros

Ref. 060506 - 3/8 (11 mm)
 Ref. 060507 - 1/2 (13 mm)
 Ref. 060508 - 3/4 (15 mm)
 Ref. 060509 - 3/4 (15 mm) - alongada
 Ref. 060510 - 1 (18 mm)
 Ref. 060511 - 1 1/4 (22 mm)
 Ref. 060518 - 1 1/2 (26 mm)



Módulo Telescópico

PARA LINHA KIT FÁCIL

Liga de cobre

Ref. 060802 - compr. 5 mm
 Ref. 060801 - compr. 10 mm



Complemento Telescópico

SEXTAVADO

Liga de cobre

Ref. 060702 - diâmetro carrapeta: 13 mm
 Ref. 060703 - diâmetro carrapeta: 15 mm

Ref. 060704 - compr. 25 mm s/ carrapeta
 Ref. 060705 - compr. 35 mm s/ carrapeta
 Ref. 060706 - compr. 50 mm s/ carrapeta

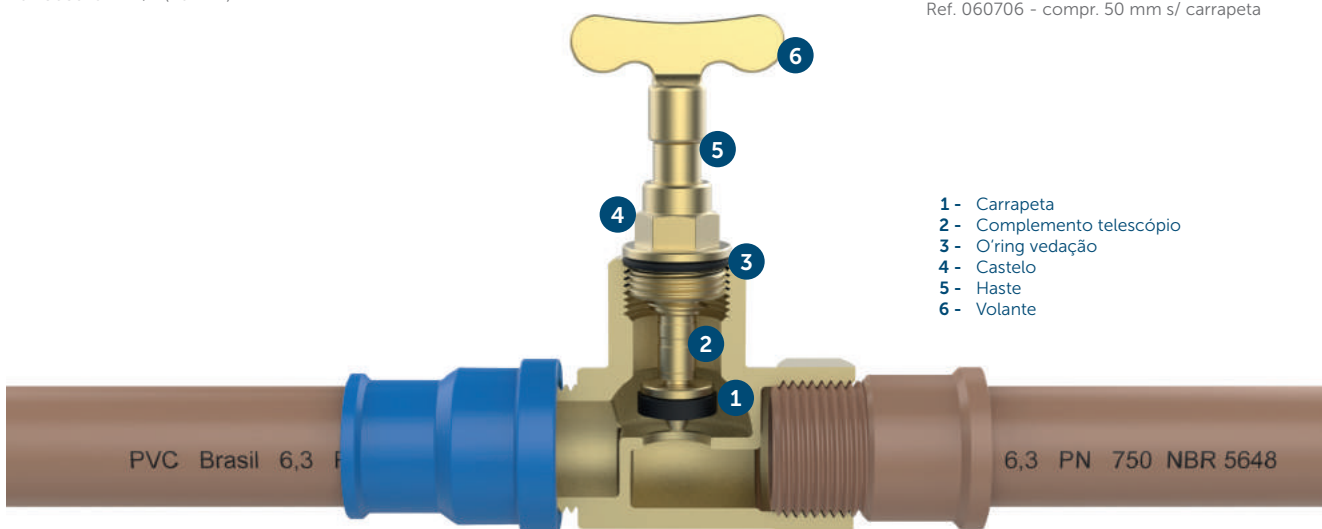

- 1 - Carrapeta
- 2 - Complemento telescópico
- 3 - O'ring vedação
- 4 - Castelo
- 5 - Haste
- 6 - Volante

PARA MÓDULO



Ref. 100828 - Para módulo de gaveta **FABRIMAR** 3/4 (289114)
 Ref. 100825 - Para módulo de gaveta **DECA** 3/4 (289107)
 Para módulo de gaveta **DOCOL** 3/4 (289103)
 Ref. 100831 - Para módulo de gaveta **DECA** 1.1/2 (289141)
 Ref. 100830 - Para módulo de gaveta **DOCOL** 1.1/2 (289162)
 Ref. 100827 - Para módulo de gaveta **DECA** Novo (289176)

PARA HASTE



Ref. 100801 - Haste da Linha Kit Fácil Pressão e MVS Pressão **DOCOL** (011601)
 Ref. 100802 - Haste da linha Kit Fácil Gaveta e MVS Gaveta **DECA** (280122)

PARA CASTELO



Ref. 100803 - Castelo da linha Kit Fácil Pressão
 Ref. 100851 - Castelo torneira e chuveiro **DOCOL**
 Castelo da linha Kit Fácil Gaveta
 Ref. 100826 - Castelo MVC **DECA** (350116)

Posicione o anel sobre essa folha e veja aquele que atende sua **NECESSIDADE**. Observe se tanto o **DIÂMETRO** quanto a **ESPESSURA** ficam adequadas.

Referências BLUKIT

100822
100864
100837
100834
100856
100805

Referências BLUKIT

100835
100865
100843
100824
100848
100840

100821
100833
100827
100825
100808
100842

100844

100831
100838
100816
100826
100801

100807

100836
100830
100828
100815
100853
100892

100855

100818
100847
100891
100802

100845

100852

100839
100832
100817
100850
100841

100803

100820
100829

100857
100854

100849

100858

KIT FÁCIL® SALVA REGISTRO® 10 EM 1



Kit Fácil® Salva Registro®



10 EM 1 | SEM ACABAMENTO

Estrias padrão FABRIMAR (G)
Ciclos: 50.000

Acompanha:

- 1 carrapeta tamanho maior
- 1 castelo padrão Docol (B)
- 1 castelo conversor padrão Fabrimar (G)
- 1 estria conversora padrão Deca (A)
- 1 estria conversora padrão Docol (B)
- 1 prolongador do castelo padrão Deca (A)
- 3 complementos alongadores
- 3 módulos de redução (9 modelos de rosca)

Ref. 060101 (+VENDIDO)

**ÚNICO COMPATÍVEL
COM ACABAMENTOS
DECA, DOCOL E
TIGRE/FABRIMAR**



Kit Fácil® Salva Registro®



10 EM 1 | COM ACABAMENTO

Estrias padrão DECA (A)
Ciclos: 50.000

Acompanha:

- 1 carrapeta tamanho maior (1)
- 3 módulos de redução (9 modelos de rosca)
- Volante, canopla e preme de ABS

Ref. 060102 - acabamento C-50 - cromado
Ref. 060103 - acabamento C-40 - cromado

KIT FÁCIL® SALVA REGISTRO® 9 EM 1



Kit Fácil® Salva Registro®



9 EM 1 | PPS SEM ACABAMENTO

Plástico de engenharia reforçado, liga de cobre e elastômero
Ciclos: 50.000

Contém no Kit:

- 1 parafuso do volante maior
- 1 parafuso do volante menor
- 1 arruela para parafuso maior
- 1 Kit Fácil®
- 1 castelo conversor para acabamento Docol
- 1 estria conversora para acabamento Docol
- 1 carrapeta tamanho maior
- 1 carrapeta tamanho menor
- 1 anel O'ring tamanho maior
- 1 anel O'ring tamanho menor
- 3 complementos alongadores
- 4 módulos de redução (8 modelos de rosca)

Ref. 061403



Kit Fácil® Salva Registro®



9 EM 1 | PPS COM ACABAMENTO

Plástico de engenharia reforçado, liga de cobre e elastômero
Ciclos: 50.000

Contém no kit:

- 1 botão do volante
- 1 parafuso do volante
- 1 volante
- 1 bucha estriada do volante
- 1 canopla
- 1 castelo da canopla
- 1 Kit Fácil®

Ref. 061420 - acabamento C-50 - cromado
Ref. 061421 - acabamento C-40 - cromado

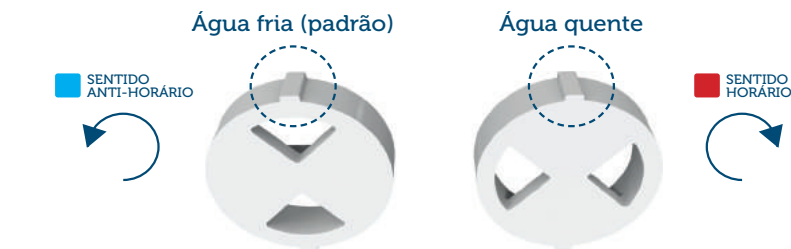

 Possibilidade de conversão de **ANTI-HORÁRIO** para **HORÁRIO**

- Substitui o mecanismo original;
- Conserta registros de pressão, torneiras e misturadores;
- O mecanismo é de 1/4 de volta;
- Sistema de acionamento rotativo;
- Mais de 200.000 ciclos de abertura e fechamento;
- Fácil manutenção;
- Suporta água quente ou fria.



CONSULTE EMBALAGEM ESPECIAL PARA 40 PEÇAS

Ref. 367111 - padrão **DOCOL**
Ref. 367112 - padrão **DECA**



PRODUTO 2 em 1
Horário e Anti-horário
Padrão **DECA** e **DOCOL**

Somente estria
Ref. 141610



MVC para Torneira



MULTIMARCAS

Ciclos: 200.000
Rosca: nº 43
Estrias padrão **DOCOL** e estria conversora **DECA** (B/A)

Aplicado a:
Lorenzetti, Imperatriz, Meber, Perflex, Brasil Metais, Oneel, Real Metais, Bogнар, Furkin, Higiban, várias marcas chinesas.

Modelos DECA:
Link, Spin, Sky, Fast, Axis, Unic, Plus, Windsor, Just, Single, Duna, Duna Clássico, Flex, Izi, Stick, Disco, Quadrata, Quadrata Classic, Twin, Twist e Dream

Ref. 367102 - Liga de cobre (**+VENDIDO**)
Ref. 427101 - PPS



MVC para Torneira



MULTIMARCAS

Liga de cobre e elastômeros
Ciclos: 200.000
Rosca: nº 43
Anti-horário

Ref. 367111 - padrão **DOCOL**
Ref. 367112 - padrão **DECA**



MVC para Misturador



MULTIMARCAS | LAVATÓRIO

Liga de cobre e elastômeros
Ciclos: 200.000
Estrias padrão **DOCOL**
Rosca: nº 43
Aplicável ao mod. 192001

Ref. 367107

MVC - MECANISMO DE VEDAÇÃO CERÂMICA (1/4 DE VOLTA)



MVC para Misturador



MULTIMARCAS | COZINHA

Liga de cobre e elastômeros
Ciclos: 200.000

Estría padrão **DOCOL**
Rosca: n° 43
Aplicável ao mod. 190415

Ref. 367106



MVC para Torneira



BLUKIT

Liga de cobre e elastômeros
Ciclos: 200.000
Rosca: n° 02
Acabamento **BLUKIT**

Estría padrão **DOCOL**

Ref. 367109



MVC para Torneira



SANCHEZ, RENO, KELLY E JED

Liga de cobre e elastômeros
Ciclos: 200.000
Rosca: n° 01

Estría padrão **DECA**
(anti-horário)

Ref. 361502 - padrão **DECA**
Ref. 361503 - padrão **DOCOL**



MVC para Registro de Pressão



ACQUA-SYSTEM DE 1/2 E 3/4

Liga de cobre e elastômeros
Acabamento: Deca e similares
Ciclos: 200.000
Rosca: n° 37
Estrias padrão **DECA** e similares (A)

Ref. 358405



MVC para Registro de Pressão



DECA DE 1/2 E 3/4 COM CASTELO

Liga de cobre e elastômeros
Acabamento: Deca e similares
Ciclos: 200.000
Rosca: n° 12
Estrias padrão **DECA** e similares (A)
O'ring Castelo: 100801

Ref. 350101



MVC para Registro de Pressão



DECA ATUAL SEM CASTELO

Liga de cobre e elastômeros
Ciclos: 200.000
Estrias padrão **DECA** e similares (A)
O'ring Castelo: 100801

Ref. 350116 (+VENDIDO)



MVC para Misturador



DE LAVATÓRIO SEM CASTELO **DECA**

Liga de cobre e elastômeros
Ciclos: 200.000
Modelo: 1875
Estrias padrão **DECA** e similares (A)

Aplicado a:
Deca: Belle Epoque Tradicional e Light, Spot, Prata, Targa e Aspen - 1875 (bica alta e baixa)

Ref. 360105



MVC para Torneira



DECA

Liga de cobre e elastômeros
Ciclos: 200.000
Modelos: 1157, 1167, 1168, 1194, 1195, 1198, 1245, 1256 e 1258
Rosca: n° 12
Estrias padrão **DECA** e similares (A)
O'ring Castelo: 100801

Ref. 360101 - com castelo



MVC para Registro de Pressão



DECA

Liga de cobre e elastômeros
Acabamento: Hansgrohe
Ciclos: 200.000
Rosca: n° 12
Estrias padrão **DOCOL** (B)

Ref. 350111



MVC para Torneira Elétrica



HYDRA LUMEN

Liga de cobre e elastômeros
Ciclos: 200.000
Estrias padrão **HYDRA**

Ref. 360134



MVC para Torneira Elétrica



HYDRA SLIM

Liga de cobre e elastômeros
Ciclos: 200.000
Estrias padrão **HYDRA**

Ref. 360135



MVC para Registro de Pressão



DOCOL BASETec PVC-PPR-LATÃO

Liga de cobre e elastômeros
Acabamento: Docol e Similares
Ciclos: 200.000
Rosca: n° 105
Estrias padrão **DOCOL**

Ref. 351618



MVC para Torneira



DOCOL

Liga de cobre e elastômeros
Acabamento: Docol e Similares
Ciclos: 200.000
Rosca: n° 26
Estrias padrão **DOCOL** (B)
O'ring Castelo: 100801

Ref. 361601



MVC para Torneira



DOCOL

Liga de cobre e elastômeros
Ciclos: 200.000
Rosca: n° 07
Estrias padrão **DOCOL** (B)
O'ring Castelo: 100801

Ref. 361603



MVC para Registro de Pressão



DOCOL DE 1/2 E 3/4

Liga de cobre e elastômeros
Acabamento: Docol e Similares
Ciclos: 200.000
Rosca: n° 07
Estrias padrão **DOCOL** (B)
O'ring Castelo: 100801

Ref. 351601 (+VENDIDO)



MVC para Torneira



DOCOL

Liga de cobre e elastômeros

Ciclos: 200.000

Estrias padrão **DOCOL** (B)

Aplicado a: modelo Gali, Torneira Lavatório City e Stillo Docol modelo novo

Ref. 361602



MVC para Torneira



DOCOL

Liga de cobre e elastômeros

Ciclos: 200.000

Estrias padrão **DOCOL** (B)

Aplicado a: modelo Primor

Ref. 361604 - com cruzeta

Ref. 361605 - sem cruzeta



MVC para Registro de Pressão



TIGRE/FABRIMAR DE 1/2 E 3/4

Liga de cobre e elastômeros

Acabamento: Deca e similares

Ciclos: 200.000

Rosca: nº 19

Estrias padrão **DECA** e similares (A)

Ref. 352005



MVC para Misturador



TIGRE/FABRIMAR DE 3/4

Código Fabrimar: CPD 02101

Liga de cobre e elastômeros

Acabamento: Fabrimar e similares

Ciclos: 200.000

Rosca: nº 43

Estrias padrão **FABRIMAR** (C)

Ref. 362002



MVC para Registro de Pressão



TIGRE/FABRIMAR DE 1/2 E 3/4

Liga de cobre e elastômeros

Acabamento: Fabrimar e similares

Ciclos: 200.000

Rosca: nº 19

Estrias padrão **FABRIMAR** (C)

O'ring Castelo: 100801

Ref. 352001



MVC para Registro de Pressão



MEBER DE 1/2 E 3/4

Liga de cobre e elastômeros

Acabamento: Deca e similares

Ciclos: 200.000

Modelo: 1418

Rosca: nº 43

Estrias padrão **DECA** (A)

O'ring Castelo: 100801

Ref. 353105



MVC para Registro de Pressão



MEBER DE 1/2 E 3/4

Liga de cobre e elastômeros

Acabamento: Deca e similares

Ciclos: 200.000

Rosca: nº 48

Estrias padrão **DECA** e similares

O'ring Castelo: 100801

Ref. 353101



MVC para Registro de Pressão



LORENZETTI

Liga de cobre e elastômeros

Acabamento: Deca e similares

Ciclos: 200.000

Rosca: nº 07

Estrias padrão **DECA** e similares (A)

O'ring Castelo: 100801

Ref. 354001



MVC para Registro de Pressão



ORIENTE

Liga de cobre e elastômeros

Acabamento: Deca e similares

Ciclos: 200.000

Rosca: nº 06

Estrias padrão **DECA** e similares (A)

O'ring Castelo: 100801

Ref. 352101



MVC para Misturador



DE COZINHA **TINCO**

Liga de cobre e elastômeros

Acabamento: Deca e similares

Ciclos: 200.000

Modelo: 2125

Rosca: nº 48

Estrias padrão **DECA** e similares (A)

O'ring Castelo: 100801

Ref. 361405



MVC para Registro de Pressão



TIGRE

Liga de cobre e elastômeros

Acabamento: Deca e similares

Ciclos: 200.000

Modelo atual

Estrias padrão **DECA** e similares (A)

Ref. 358201



Vedante

Material: Elastômeros

Diâmetro: 16 mm

Água quente/Fria

Ref. 101720



Vedante

Material: Elastômeros

Diâmetro: 14 mm

Água quente/Fria

Ref. 101735



MVS para Registro de Pressão



ADRIÁTICA / LORENZETTI

Ciclos: 50.000
Rosca: n° 07
Estrias padrão **DECA** e similares (A)

Ref. 011203 - Liga de Cobre
Ref. 404001 - PPS (**UNIFICADO**)



MVS para Torneira



ADRIÁTICA / JED

Ciclos: 50.000
Rosca: n° 07
Estrias padrão **DECA** e similares (A)

Ref. 021203 - Liga de Cobre
Ref. 417801 - PPS (**UNIFICADO**)



MVS para Registro de Pressão



ADMO

Ciclos: 50.000
Rosca: n° 12
Estrias padrão **DECA** e similares (A)

Ref. 014201



MVS para Torneira



BIG-LU / BOGNAR / IMETAL / NERY / SAMER

Ciclos: 50.000
Rosca: n° 29
Estrias padrão **DECA** e similares (A)

Ref. 026901 - Liga de Cobre
Ref. 412902 - PPS (**UNIFICADO**)



MVS para Torneira



BOGNAR / BIG-LU / IMETAL / NERY / SAMER

Ciclos: 50.000
Rosca: n° 29
Estrias padrão **DECA** e similares (A)

Ref. 024401 - Liga de Cobre
Ref. 412902 - PPS (**UNIFICADO**)



MVS para Registro de Pressão



BOMETAL

Ciclos: 50.000
Rosca: n° 50
Estrias padrão **DECA** e similares (A)

Ref. 012301 - Liga de Cobre
Ref. 402301



MVS para Torneira



BOMETAL

Ciclos: 50.000
Modelo: C-51 e C-75
Rosca: n° 50
Estrias padrão **DECA** e similares (A)

Ref. 022302 - Liga de Cobre
Ref. 412302 - PPS



MVS para Torneira



BOMETAL

Ciclos: 50.000
Haste: longa
Rosca: n° 13
Estrias padrão **DECA** e similares (A)

Ref. 022301 - Liga de Cobre
Ref. 412301 - PPS



MVS para Registro de Pressão



BOGNAR

Ciclos: 50.000
Rosca: n° 01
Estrias padrão **DECA** e similares (A)
O'ring Castelo: 100801

Ref. 014401



MVS para Registro de Pressão



CELITE

Ciclos: 50.000
Rosca: grossa n° 42
Perfil quadrado padrão Celite (J)
O'ring Castelo: 100802

Ref. 011101 - Liga de Cobre
Ref. 401101 - PPS



MVS para Torneira



CELITE

Ciclos: 50.000
Rosca: grossa n° 42
Perfil quadrado padrão Celite (J)
O'ring Castelo: 100801

Ref. 021101 - Liga de Cobre
Ref. 411101 - PPS



MVS para Registro de Pressão



COM CASTELO DECA

Ciclos: 50.000
Estrias padrão **DECA**

Ref. 010113 - haste cromada
Ref. 010115 - haste s/acabamento

**CONSULTE
EMBALAGEM ESPECIAL
PARA 20 PEÇAS**
REF. 010101



1
n° 1 em
Vendas



MVS para Registro de Pressão



SEM CASTELO DECA DE 1/2 E 3/4

Ciclos: 50.000
Estrias padrão **DECA** e similares (A)

Ref. 010101 - haste cromada
Ref. 010114 - haste s/acabamento

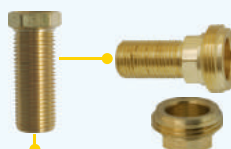

**PROLONGADOR
PARA CASTELO
pressão e gaveta
DECA** e similares
Ref. 160121
Obs: 40mm



**PARA
TORNEIRA**
Ref. 020108

Castelo para Registro



DE PRESSÃO DECA

Rosca: n° 12
comprimento: 25 mm
Ref. 010102

comprimento: 18 mm para misturador
Ref. 010103



MVS para Torneira



SEM CASTELO **DECA**

Ciclos: 50.000
Modelo: 1157, 1167, 1168, 1194, 1195, 1198, 1245, 1256 e 1258
Estrias padrão **DECA** e similares (A)

Ref. 020106 (+VENDIDO)



MVS para Torneira



SEM CASTELO **DECA**

Ciclos: 50.000
Modelo: 1167, 1168, 1193, 1195, 1198, 1199, 1245, 1256 e 1257
Estrias padrão **DECA** e similares (A)

Ref. 020107



MVS para Bidê e Lavatório



SEM CASTELO **DECA**

Ciclos: 50.000
Modelo: 1198, 1199 C-52
Estrias padrão **DECA** e similares (A)

Ref. 040101



MVS para Torneira



SEM CASTELO **DECA**

Ciclos: 50.000
Haste: curta
Modelo: 1130, 1152, 1153, 1154, 1155, 1158, 1159, 1193 e 1245
Estrias padrão **DECA** e similares (A)

Ref. 020101



MVS para Torneira



DECA

Ciclos: 50.000
Haste: curta
Modelo: 1198 e SPOT
Rosca: nº 12
Estrias padrão **DECA** e similares (A)

Ref. 020109 - Liga de Cobre
Ref. 410101 - PPS



MVS para Torneira



SEM CASTELO **DECA**

Ciclos: 50.000
Haste: longa
Modelo: 1130, 1152, 1153, 1154, 1159, 1193 e 1259
Estrias padrão **DECA** e similares (A)

Ref. 020102



MVS para Torneira



SEM CASTELO **DECA MAX**

Plásticos de engenharia
Ciclos: 50.000
Modelo: 4688-002

Para volante com rosca
Ref. 020111

Estria padrão **DECA**
Ref. 020112



MVS para Bidê, Lavatório e Ducha



GRAN ANTIQUE DOCOL

Ciclos: 50.000
Rosca: nº 07
Estrias padrão **DOCOL** e similares (A)

Ref. 041601 - Liga de Cobre
Ref. 401602 - PPS



MVS para Misturador de Cozinha



DOCOL

Ciclos: 50.000
Rosca: nº 07
Estrias padrão **DOCOL** (B)
O'ring Castelo: 100801

Ref. 021607 - Liga de Cobre
Ref. 411606 - PPS



MVS para Misturador de Cozinha



DOCOL

Ciclos: 50.000
Haste: menor
Rosca: nº 26
Estrias padrão **DOCOL** e similares (A)

Ref. 021605 - Liga de Cobre
Ref. 411603 - PPS



MVS para Torneira



DOCOL

Ciclos: 50.000
Rosca: nº 26
Estrias padrão **DOCOL** (B)
*substitui modelo original de plásticos de engenharia

Ref. 021602 - Liga de Cobre
Ref. 411601 - PPS



MVS para Torneira



COM SEXTAVADO LONGO **DOCOL**

Ciclos: 50.000
Rosca: nº 26
Estrias padrão **DOCOL** (B)

Ref. 021606 - Liga de Cobre
Ref. 411602 - PPS



MVS para Torneira



COM SEXTAVADO **CURTO E LONGO DOCOL**

Ciclos: 50.000
Rosca: nº 07
Estrias padrão **DOCOL** (B)
*substitui o Ref.021610

Ref. 021601 - Liga de Cobre
Ref. 411605 - PPS

Acompanha dois Vedantes



MVS para Bidê, Lavatório e Ducha



GRAN ANTIQUE DOCOL

Ciclos: 50.000
Rosca: nº 26
Estrias padrão **DOCOL** e similares (A)

Ref. 021608 - Liga de Cobre
Ref. 411604 - PPS



MVS para Registro de Pressão



DOCOL

Ciclos: 50.000
Rosca: nº 07
Estrias padrão **DOCOL** (B)
O'ring Castelo: 100801

Ref. 011601 (+VENDIDO)

Com castelo em poliacetal
Ref. 011607 - Liga de Cobre

Ref. 401601 - PPS
Ref. 011608 - Sede

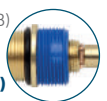



MVS para Torneira

ESTEVES

Ciclos: 50.000
Haste: maior
Rosca: nº 29
Estrias padrão **DECA** e similares (A)

Ref. 028901 - Liga de Cobre
Ref. 418901 - PPS - Haste cromada



MVS para Torneira

ESTEVES / FORUSI

Ciclos 50.000
Haste: menor
Rosca: nº 29
Estrias padrão **DECA** e similares (A)

Ref. 028902 - Liga de Cobre haste cromada
Ref. 020602 - Liga de Cobre haste bruta
Ref. 418902 - PPS - Haste cromada



Castelo para Registro

DE PRESSÃO FABRINEL

Rosca interna
Comprimento: 36,8 mm

Ref. 012203



MVS para Registro de Pressão e Misturador

FANI

Ciclos: 50.000
Rosca: nº 07
Modelo: 416
Estrias: **DECA** e similares (A)

Ref. 016201 - Liga de Cobre
Ref. 406201 - PPS



MVS para Torneira de Bica Móvel

FANI

Ciclos: 50.000
Rosca: nº 07
Modelo: C-50
Estrias: **DECA** e similares (A)

Ref. 026201 - Liga de Cobre
Ref. 414501 - PPS



MVS para Misturador

FORUSI

Ciclos: 50.000
Modelo: atual, 1875 e 1895
Rosca: nº 29
Estrias: padrão **DECA** e similares (A)

Ref. 010604 - Liga de Cobre
Ref. 400601 - PPS



MVS para Registro de Pressão

FORUSI

Ciclos: 50.000
Modelo: atual
Rosca: nº 29
Estrias: padrão **DECA** e similares (A)
*substitui modelo original de poliacetal

Ref. 010603 - Liga de Cobre
Ref. 400602 - PPS



MVS para Torneira

FORUSI / ESTEVES

Ciclos: 50.000
Modelo: 1194, 2158, 2160, 2161, 2170, 2172 e 3159
Rosca: nº 29
Estrias padrão **DECA** e similares (A)

Ref. 020602 - Liga de Cobre haste bruta
Ref. 028902 - Liga de Cobre haste cromada

Ref. 410601 - PPS haste cromada



MVS para Torneira

FORUSI

Ciclos: 50.000
Modelo: 1157, 1158, 1164, 2160, 2161, 2170, 2172 e 3159
Rosca: nº 29
Estrias: padrão **DECA** e similares (A)

Ref. 020603 - Liga de Cobre
Ref. 410602 - PPS



MVS para Registro de Pressão

FORUSI / KELLY

Ciclos: 50.000
Rosca: nº 07

Ref. 010601 - Liga de Cobre estria somente **DOCOL**
Ref. 010602 - Liga de Cobre estria somente **DECA**

Ref. 014502 - Liga de Cobre **UNIFICADO ESTRIAS DOCOL E DECA**
Ref. 404502 - PPS



MVS para Torneira

FORUSI / KELLY

Ciclos: 50.000
Rosca: nº 07

Ref. 020601 - Liga de Cobre estria somente **DOCOL**
Ref. 020605 - Liga de Cobre estria somente **DECA**

Ref. 024502 - Liga de Cobre **UNIFICADO ESTRIAS DOCOL E DECA**
Ref. 414501 - PPS



MVS para Torneira

IMETAL / BIG-LU / BOGNAR / NERY / SAMER

Ciclos: 50.000
Rosca: nº 29
Modelo: atual
Estrias: **DECA** e similares (A)

Ref. 023204 - Liga de Cobre
Ref. 412902 - PPS (**UNIFICADO**)



MVS para Torneira

IMETAL / BIG-LU / BOGNAR / NERY / SAMER

Ciclos: 50.000
Rosca: nº 29
Modelo: atual
Estrias: **DECA** e similares (A)

Ref. 023204 - Liga de Cobre
Ref. 412902 - PPS (**UNIFICADO**)



MVS para Torneira de Bica Móvel

JED / ADRIÁTICA

Ciclos: 50.000
Rosca: nº 07
Estrias: **DECA** e similares (A)

Ref. 027801 - Liga de Cobre (**UNIFICADO**)



MVS para Torneira

KELLY

Ciclos: 50.000
Modelo: atual
Rosca: nº 07
Acompanham 2 modelos de estrias:
Estrias padrão **DECA** e similares (A)
Estrias padrão **DOCOL** (B)

Ref. 024502 - Liga de Cobre
Ref. 414501 - PPS





MVS para Registro de Pressão



KELLY

Ciclos: 50.000
 Modelo: antigo
 Rosca: nº 05
Acompanham 2 modelos de estrias:
 Estrias padrão **DECA** e similares (A)
 Estrias padrão **DOCOL** (B)

Ref. 014501 - Liga de Cobre
 Ref. 404501 - PPS



MVS para Torneira



KELLY

Ciclos: 50.000
 Modelo: antigo
 Rosca: nº 05
Acompanham 2 modelos de estrias:
 Estrias padrão **DECA** e similares (A)
 Estrias padrão **DOCOL** (B)

Ref. 024501 - Liga de Cobre **(+VENDIDO)**
 Ref. 414503 - PPS



MVS para Torneira



KELLY

Ciclos: 50.000
 Rosca: nº 05
 Modelo: 162, 163, 71, 72, 95 e 1004-CR
 Estrias: **DOCOL** e similares (A)

Ref. 024503 - Liga de Cobre
 Ref. 414502 - PPS

Acompanha



MVS para Registro de Pressão



KELLY / FORUSI

Ciclos: 50.000
 Rosca: nº 07

Ref. 010601 - Liga de Cobre estria somente **DOCOL**
 Ref. 010602 - Liga de Cobre estria somente **DECA**

Ref. 014502 - Liga de Cobre
 Ref. 404502 - PPS



MVS para Registro de Pressão



LORENZETTI / ADRIÁTICA

Ciclos: 50.000
 Rosca: nº 07
 Estrias padrão **DECA** e similares (A)

Ref. 014001 - Liga de Cobre
 Ref. 404001 - PPS **(UNIFICADO)**



MVS para Torneira



LEISER

Ciclos: 50.000
 Rosca: nº 07
 Estrias padrão **DECA** e similares (A)

Ref. 026401



MVS para Toneira



MADIA

Ciclos: 50.000
 Rosca: nº 03
 Modelo: 1134, 1196, 1350, 1351, 1352, 1353, 1456, 1459 e 1910
 Estrias: **DECA** e similares (A)

Ref. 020903 - Liga de Cobre
 Ref. 410902 - PPS



MVS para Toneira de Cozinha



MADIA

Ciclos: 50.000
 Rosca: nº 03
 Estrias: **DECA** e similares (A)

Ref. 020902 - Liga de Cobre
 Ref. 410901 - PPS



MVS para Registro de Pressão



MADIA

Ciclos: 50.000
 Rosca: nº 03
 Estrias: **DECA** e similares (A)

Ref. 010901 - Liga de Cobre
 Ref. 400901 - PPS



MVS para Registro de Pressão



MADIA

Ciclos: 50.000
 Rosca: nº 03
 Estrias: **DECA** e similares (A)

Ref. 010902 - Liga de Cobre
 Ref. 400902 - PPS



MVS para Torneira



MAFAL

Ciclos: 50.000
 Modelo: 1194, 1196, 1197, 1198, 1199, 2001, 2005, 2025, 2160, 2166, 2167, 2168, 2175, 2256, 2258, 2268 e 2294
 Rosca: nº 07
 Estrias padrão **DECA** e similares (A)

Ref. 023703



MVS para Registro de Pressão



MAFAL

Ciclos: 50.000
 Rosca: nº 07
 Estrias padrão **DECA** e similares (A)

Ref. 013701



MVS para Torneira



SEM CASTELO MAFAL

Ciclos: 50.000
 Modelo: 1168
 Estrias padrão **DECA** e similares (A)

Ref. 023706



MVS para Registro de Pressão



MEBER

Ciclos: 50.000
 Modelo: atual
 Rosca: nº 48
 Estrias padrão **DECA** e similares (A)

Ref. 013103 - Liga de Cobre
 Ref. 403103 - PPS



MVS para Registro de Pressão



MEBER SUPERNOVA

Liga de cobre e elastômeros
 Acabamento: Deca e similares
 Rosca: nº 48
 Estrias padrão **DECA** e similares

Ref. 013104



MVS para Torneira



SEM CASTELO **MEBER**

Ciclos: 50.000
Modelos: 1193, 1151, 1160, 1162, 1170, 1169, 1173 e 1174
Estrias padrão **DECA** e similares (A)

Ref. 023104 - Liga de Cobre



MVS para Registro de Pressão



MEBER

Ciclos: 50.000
Rosca: nº 33
Modelo: antigo
Estrias: **DECA** e similares (A)

Ref. 013102 - Liga de Cobre
Ref. 403102 - PPS



MVS para Registro de Pressão



MEBER

Ciclos: 50.000
Rosca: nº 33
Estrias: **DECA** e similares (A)

Ref. 013101 - Liga de Cobre
Ref. 403101 - PPS



MVS para Registro de Pressão



NERY

Ciclos: 50.000
Rosca: nº 29
Estrias: **DECA** e similares (A)

Ref. 012902 - Liga de Cobre
Ref. 412901 - PPS



MVS para Registro de Pressão



NERY

Ciclos: 50.000
Rosca: nº 07
Estrias: **DECA** e similares (A)

Ref. 012901 - Liga de Cobre
Ref. 402901 - PPS



MVS para Torneira



NERY / BIG-LU / BOGNAR / IMETAL / SAMER

Ciclos: 50.000
Rosca: nº 29
Neyr Modelos: 1177, 1185, 1190, 1194, 1195, 1286, 1287, 1298 e 2000
Estrias: **DECA** e similares (A)

Ref. 022902 - Liga de Cobre
Ref. 412902 - PPS (**UNIFICADO**)



MVS para Torneira



NERY

Ciclos: 50.000
Rosca: nº 07
Modelo: 1175, 1177 e 1185
Estrias: **DECA** e similares (A)

Ref. 022901 - Liga de Cobre
Ref. 412901 - PPS



MVS para Registro de Pressão



ORIENTE

Ciclos: 50.000
Cód. fabricante: 0550001
Modelo: atual com estria antiga
Rosca: nº 06
Estrias padrão **ORIENTE** (H)

Ref. 012101 - Liga de Cobre
Ref. 402101 - PPS



MVS para Registro de Pressão



ORIENTE

Ciclos: 50.000
Cód. fabricante: 0550001
Modelo: atual
Rosca: nº 06
Estrias padrão **DECA** e similares (A)

Ref. 012102 - Liga de Cobre (**+VENDIDO**)
Ref. 402102 - PPS



MVS para Torneira



ORIENTE

Ciclos: 50.000
Cód. fabricante: 0510010
Modelo: atual
Rosca: nº 06
Estrias padrão **DECA** e similares (A)

Ref. 022102 - Liga de Cobre (**+VENDIDO**)
Ref. 412103 - PPS



MVS para Torneira



ORIENTE

Ciclos: 50.000
Cód. fabricante: 0510009
Modelo: atual
Rosca: nº 06
Estrias padrão **DECA** e similares (A)

Ref. 022104 - Liga de Cobre
Ref. 412101 - PPS



MVS para Torneira



SEM CASTELO **ORIENTE**

Ciclos: 50.000
Cód. fabricante: 0510068
Modelo: 1126, 1130, 1158, 1161 e 1193
Estrias padrão **DECA** e similares (A)

Ref. 022106 - Liga de Cobre



MVS para Torneira



ORIENTE

Ciclos: 50.000
Rosca: nº 06
Modelo: atual com estria antiga
Estrias padrão **ORIENTE**

Ref. 022101 - Liga de Cobre
Ref. 412102 - PPS



MVS para Torneira



SEM CASTELO **PERFLEX**

Ciclos: 50.000
Modelo: 1130, 1131, 1152, 1158, 1178 e 1193
Estrias padrão **DECA** e similares (A)

Ref. 023003 - Liga de Cobre



MVS para Registro de Pressão



PERFLEX

Ciclos 50.000
Rosca: nº 07
Estrias: **DECA** e similares (A)

Ref. 013001 - Liga de Cobre
Ref. 403001 - PPS



MVS para Registro de Pressão



POLY

Ciclos: 50.000
Modelo: atual
Rosca: nº 05
Estrias padrão **DECA** e similares (A)

Ref. 011903 - Liga de Cobre
Ref. 401902 - PPS



MVS para Torneira



POLY

Ciclos: 50.000
Modelo: atual
Rosca: nº 05
Estrias padrão **DECA** e similares (A)

Ref. 021903 - Liga de Cobre



MVS para Registro de Pressão



POLY

Ciclos: 50.000
Rosca: nº 05
Modelo: antigo
Estrias Perfil Facetado **POLY**

Ref. 011902 - Liga de Cobre
Re. 401901 - PPS



MVS para Registro de Pressão



RIO

Ciclos: 50.000
Rosca: nº 09
Estrias padrão **DECA** e similares (A)

Ref. 012601 - Liga de Cobre
Ref. 402601 - PPS



MVS para Torneira



RIO

Ciclos: 50.000
Rosca: nº 09
Estrias padrão **DECA** e similares (A)

Ref. 022601 - Liga de Cobre
Ref. 412601 - PPS



MVS para Registro de Pressão



TIGRE

Ciclos: 50.000
Modelo: S30
Estrias padrão **DECA** e similares (A)

Ref. 018203 - Liga de Cobre
Ref. 408201 - PPS



MVS para Registro de Pressão



TIGRE/FABRIMAR

Ciclos: 50.000
Modelo: 2373
Rosca: nº 19
Estrias padrão **FABRIMAR** (C)

Ref. 012001 - Liga de Cobre
Ref. 402001 - PPS



MVS para Registro de Pressão



TIGRE/FABRIMAR

Código FABRIMAR: CPD 01090
Ciclos: 50.000
Modelo: Antigo 9006
Rosca: nº 19
Estrias padrão **FABRIMAR** (C)

Ref. 042002 - Liga de Cobre



MVS para Registro de Pressão



TIGRE/FABRIMAR

Código FABRIMAR: CPD 09006
Ciclos: 50.000
Modelo: Antigo 9006
Rosca: nº 19
Estrias padrão **FABRIMAR** (C)

Ref. 042001 - Liga de Cobre
Ref. 402002 - PPS



MVS para Torneira



TIGRE/FABRIMAR

Ciclos: 50.000
Modelo: 1147, 1158, 1167, 1168, 1170, 1171, 1245, 1256 e 1258
Rosca: nº 19
Estrias padrão **FABRIMAR** (C)

Ref. 022001 - Liga de Cobre (+VENDIDO)
Ref. 412001 - PPS



MVS para Misturador e Lavatório



TIGRE/FABRIMAR

Código FABRIMAR: CPD 00514
Ciclos: 50.000
Rosca: nº 43
Estrias padrão **FABRIMAR** (C)

Ref. 022004 - Liga de Cobre
Ref. 412003 - PPS

Compatível com os modelos **BASECLIC** (Lyon, Ascot Digital Line, Domani, Duello, Oggi, Aquarius, Misty, Trezzo, Squadra, Orion e Jolie)

- Modelos de **TORNEIRAS** (de máquina e cozinha) e **LAVATÓRIOS** que usam a prensa de canopla CPD 00185: Image, Lyon, Ascot, Digital Line, Domani, Duello e Oggi;
- Modelos de **TORNEIRAS** que usam a prensa de canopla CPD 04323: Soho;
- Modelos de **LAVATÓRIOS** que usam a prensa de canopla CPD 01639: Aquarius;
- Modelos de **LAVATÓRIOS** que não usam prensa: Misty;
- Modelos de **MISTURADORES** que não usam prensa: Trezzo, Squadra, Orion, Jolie e Duello.



MVS para Registro de Pressão



TIGRE/FABRIMAR

Ciclos: 50.000
Rosca: nº 19
Estrias padrão **DECA** e similares (A)

Ref. 012009 - Liga de Cobre



MVS para Torneira



TIGRE/FABRIMAR

Código FABRIMAR: CPD 01091
Ciclos: 50.000
Rosca: nº 19
Estrias padrão **FABRIMAR** (C)

Ref. 022003 - Liga de Cobre
Ref. 412002 - PPS



MVS para Torneira



TIGRE/FABRIMAR

Ciclos: 50.000
Haste: menor
Rosca: nº 43
Estrias padrão **FABRIMAR** e similares

Ref. 022005 - Liga de Cobre
Ref. 412004 - PPS

MVS - MECANISMO DE VEDAÇÃO SUBSTITUÍVEL (Pressão, torneiras e misturadores)



Sede para Registro de Pressão

PADRÃO **FABRIMAR**

Modelo **1185**
Aplicável ao modelo **320201**

Ref. 012002 - Plást. de Engenharia
Ref. 012004 - Liga de Cobre



Kit de Vedante para Torneira

PRATIKA **FABRIMAR**

Código **FABRIMAR**: CPD 09312
Liga de cobre

Ref. 101725 - com sede
Ref. 101726 - sem sede



MVS para Registro de Pressão



Fabricado no Brasil

TINCO

Ciclos 50.000
Modelo: 2181
Rosca: nº 48
Estrias padrão **DECA** e similares (A)

Ref. 011401 - Liga de Cobre
(+VENDIDO)
Ref. 401401 - PPS



MVS para Registro de Pressão



Fabricado no Brasil

TINCO

Ciclos: 50.000
Haste: menor
Modelo: 2181
Rosca: nº 48
Estrias padrão **DECA** e similares (A)

Ref. 011404 - Liga de Cobre
Ref. 401403 - PPS

Obs: Sextavado Maior



MVS para Registro de Pressão



Fabricado no Brasil

TINCO

Ciclos: 50.000
Rosca: nº 48
Estrias padrão **DECA** e similares (A)
*perfil sextavado menor

Ref. 011403 - Liga de Cobre
Ref. 401402 - PPS



MVS para Registro de Pressão



Fabricado no Brasil

SEM CASTELO TINCO

Ciclos: 50.000
Modelo: 2181
Estrias padrão **DECA** e similares (A)

Ref. 011406 - Liga de Cobre



MVS para Torneira



Fabricado no Brasil

TINCO

Ciclos: 50.000
Haste: menor
Modelo: 2176
Rosca: nº 48
Estrias padrão **DECA** e similares (A)

Ref. 021402 - Liga de Cobre



MVS para Torneira



Fabricado no Brasil

TINCO

Ciclos: 50.000
Haste: maior
Modelo: 2193
Rosca: nº 48
Estrias padrão **DECA** e similares (A)

Ref. 021401 - Liga de Cobre

BUCHAS MVS | REGISTRO E TORNEIRA



Material: Plástico de engenharia

PADRÃO **IMETAL**

11,5 mm (A) x 16 mm (B) x 19 mm (C)
Ref. 102406

PADRÃO **ARGUS | BOMETAL**

13 mm (A) x 18 mm (B) x 20 mm (C)
Ref. 102407

PADRÃO **BOMETAL | MIF**

13 mm (A) x 16 mm (B) x 17 mm (C)
Ref. 102408

PADRÃO **ADMO | FABRINEL | NORTE-SUL**

11,5 mm (A) x 18 mm (B) x 19 mm (C)
Ref. 102409

PADRÃO **FABRINEL | MAFAL | ARGUS MF | PERFLEX | ROMIS**

11,5 mm (A) x 17,5 mm (B) x 25,5 mm (C)
Ref. 102410

PADRÃO **FORUSI | TINCO**

15 mm (A) x 18,5 mm (B) x 19,5 mm (C)
Ref. 102411

PADRÃO **MAFAL**

11,5 mm (A) x 16,5 mm (B) x 25 mm (C)
Ref. 102412

PADRÃO **BOMETAL**

13 mm (A) x 18 mm (B) x 20 mm (C)
Ref. 102413

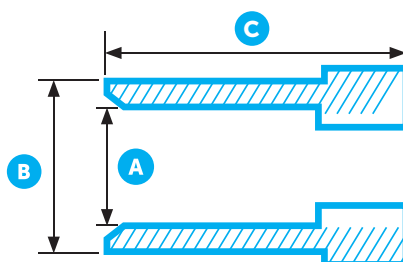

Corte Transversal



BANHEIRO



COZINHA



QUALIDADE
Blukit
para a casa inteira

LAVANDERIA



ÁREA EXTERNA



KIT FÁCIL® REGISTRO DE GAVETA

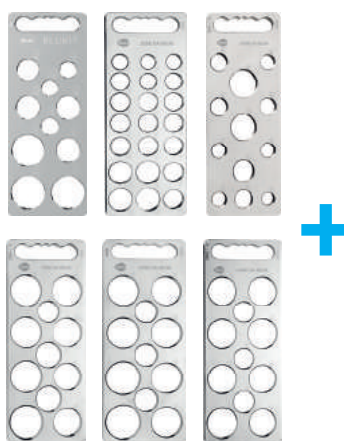
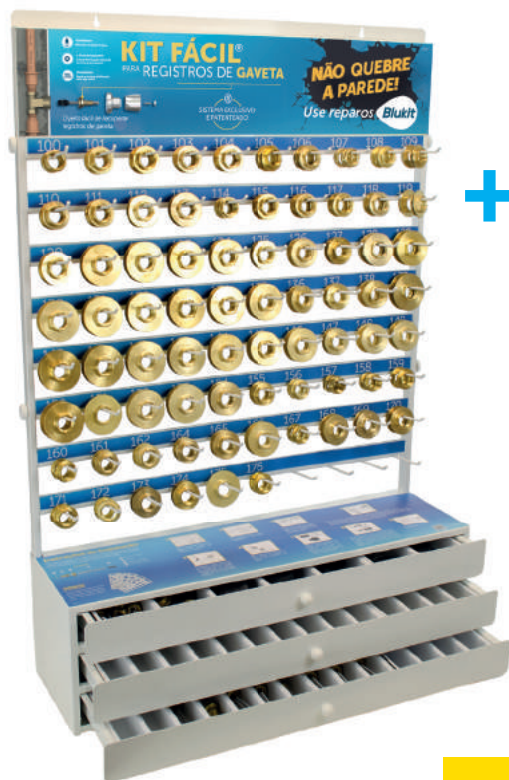

Gabarito de rosca do nº 100 ao 178

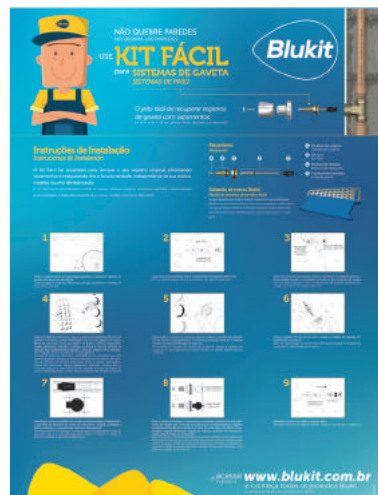

Banner passo a passo

Expositor de módulos

Kit Completo para Registro de Gaveta

Módulos de redução para registro de gaveta do nº 100 ao 178 com 2 peças de cada

Cunha emborrachada (EPDM) Temperatura máxima: 70 °C do nº 10 ao 370 com 2 peças de cada

Kit Fácil para gaveta

Ref. 289201 - 20 peças
Ref. 289202 - 5 peças
Ref. 289203 - 5 peças

1 expositor de módulos + Banner

Ref. 101316

6 gabaritos de rosca do nº 100 ao 178

Ref. 320103
Ref. 320104
Ref. 320105
Ref. 320106
Ref. 320109
Ref. 320112

MÓDULO DE REDUÇÃO

Ref. 289101 - nº 100 (3 peças)	Ref. 289127 - nº 126 (1 peça)	Ref. 289153 - nº 152 (1 peça)
Ref. 289102 - nº 101 (6 peças)	Ref. 289128 - nº 127 (2 peças)	Ref. 289154 - nº 153 (3 peças)
Ref. 289103 - nº 102 (3 peças)	Ref. 289129 - nº 128 (1 peça)	Ref. 289155 - nº 154 (1 peças)
Ref. 289104 - nº 103 (3 peças)	Ref. 289130 - nº 129 (1 peça)	Ref. 289156 - nº 155 (1 peças)
Ref. 289105 - nº 104 (3 peças)	Ref. 289131 - nº 130 (2 peças)	Ref. 289157 - nº 156 (2 peças)
Ref. 289106 - nº 105 (2 peças)	Ref. 289132 - nº 131 (1 peça)	Ref. 289158 - nº 157 (1 peça)
Ref. 289107 - nº 106 (6 peças)	Ref. 289133 - nº 132 (2 peças)	Ref. 289159 - nº 158 (3 peças)
Ref. 289108 - nº 107 (2 peças)	Ref. 289134 - nº 133 (1 peça)	Ref. 289160 - nº 159 (1 peça)
Ref. 289109 - nº 108 (2 peças)	Ref. 289135 - nº 134 (1 peça)	Ref. 289161 - nº 160 (1 peça)
Ref. 289110 - nº 109 (3 peças)	Ref. 289136 - nº 135 (3 peças)	Ref. 289162 - nº 161 (1 peça)
Ref. 289111 - nº 110 (6 peças)	Ref. 289137 - nº 136 (2 peças)	Ref. 289163 - nº 162 (1 peça)
Ref. 289112 - nº 111 (2 peças)	Ref. 289138 - nº 137 (1 peça)	Ref. 289165 - nº 164 (1 peça)
Ref. 289113 - nº 112 (2 peças)	Ref. 289139 - nº 138 (1 peça)	Ref. 289166 - nº 165 (1 peça)
Ref. 289114 - nº 113 (2 peças)	Ref. 289140 - nº 139 (3 peças)	Ref. 289167 - nº 166 (2 peças)
Ref. 289115 - nº 114 (2 peças)	Ref. 289141 - nº 140 (3 peças)	Ref. 289168 - nº 167 (2 peças)
Ref. 289116 - nº 115 (3 peças)	Ref. 289142 - nº 141 (2 peças)	Ref. 289169 - nº 168 (1 peça)
Ref. 289117 - nº 116 (3 peças)	Ref. 289143 - nº 142 (1 peça)	Ref. 289170 - nº 169 (1 peça)
Ref. 289118 - nº 117 (3 peças)	Ref. 289144 - nº 143 (1 peça)	Ref. 289176 - nº 170 (1 peça)
Ref. 289119 - nº 118 (3 peças)	Ref. 289145 - nº 144 (2 peças)	Ref. 289177 - nº 171 (1 peça)
Ref. 289120 - nº 119 (3 peças)	Ref. 289146 - nº 145 (3 peças)	Ref. 289173 - nº 172 (1 peça)
Ref. 289121 - nº 120 (3 peças)	Ref. 289147 - nº 146 (3 peças)	Ref. 289174 - nº 173 (3 peças)
Ref. 289122 - nº 121 (2 peças)	Ref. 289148 - nº 147 (1 peça)	Ref. 289175 - nº 174 (1 peça)
Ref. 289123 - nº 122 (3 peças)	Ref. 289149 - nº 148 (1 peça)	Ref. 289178 - nº 175 (1 peça)
Ref. 289124 - nº 123 (1 peça)	Ref. 289150 - nº 149 (2 peças)	Ref. 289179 - nº 176 (1 peça)
Ref. 289125 - nº 124 (2 peças)	Ref. 289151 - nº 150 (2 peças)	Ref. 289181 - nº 177 (1 peça)
Ref. 289126 - nº 125 (1 peça)	Ref. 289152 - nº 151 (2 peças)	Ref. 289182 - nº 178 (1 peça)



Módulo de Redução

PARA REGISTROS DE GAVETA
Liga de cobre



Ref. 289101 - rosca nº 100	Ref. 289116 - rosca nº 115	Ref. 289131 - rosca nº 130
Ref. 289102 - rosca nº 101	Ref. 289117 - rosca nº 116	Ref. 289132 - rosca nº 131
Ref. 289103 - rosca nº 102 (+VENDIDO)	Ref. 289118 - rosca nº 117	Ref. 289133 - rosca nº 132
Ref. 289104 - rosca nº 103	Ref. 289119 - rosca nº 118	Ref. 289134 - rosca nº 133
Ref. 289105 - rosca nº 104 (+VENDIDO)	Ref. 289120 - rosca nº 119	Ref. 289135 - rosca nº 134
Ref. 289106 - rosca nº 105 (+VENDIDO)	Ref. 289121 - rosca nº 120	Ref. 289136 - rosca nº 135
Ref. 289107 - rosca nº 106 (+VENDIDO)	Ref. 289122 - rosca nº 121	Ref. 289137 - rosca nº 136
Ref. 289108 - rosca nº 107	Ref. 289123 - rosca nº 122	Ref. 289138 - rosca nº 137
Ref. 289109 - rosca nº 108	Ref. 289124 - rosca nº 123	Ref. 289139 - rosca nº 138
Ref. 289110 - rosca nº 109	Ref. 289125 - rosca nº 124	Ref. 289140 - rosca nº 139
Ref. 289111 - rosca nº 110 (+VENDIDO)	Ref. 289126 - rosca nº 125	Ref. 289141 - rosca nº 140
Ref. 289112 - rosca nº 111	Ref. 289127 - rosca nº 126	Ref. 289142 - rosca nº 141
Ref. 289113 - rosca nº 112	Ref. 289128 - rosca nº 127	Ref. 289143 - rosca nº 142
Ref. 289114 - rosca nº 113	Ref. 289129 - rosca nº 128	Ref. 289144 - rosca nº 143
Ref. 289115 - rosca nº 114	Ref. 289130 - rosca nº 129	Ref. 289145 - rosca nº 144



Módulo de Redução

PARA REGISTROS DE GAVETA **DECA**

Liga de cobre
Volante amarelo

Ref. 289164 - bitola 3/4
Ref. 289180 - bitola 1



Kit Fácil®

PARA REGISTRO DE GAVETA

Acabamento: Deca
Ciclos: 10.000
Estrias padrão **DECA** e similares (A)

Ref. 289201



Kit Fácil®

PARA REGISTRO DE GAVETA

Acabamento: Fabrimar
Ciclos: 10.000
Estrias padrão **FABRIMAR** (C)

Ref. 289203



Kit Fácil®

PARA REGISTRO DE GAVETA

Acabamento: Docol
Ciclos: 10.000
Estrias padrão **DOCOL** (B)

Ref. 289202



IDEAL PARA CONVERSÃO

Kit Fácil®

PARA REGISTRO DE GAVETA

Liga de cobre, plástico de engenharia e elastômeros

Acabamento: Deca Dream/Polo
Ciclos: 10.000
Estrias padrão **DOCOL** (B)
*acompanha conversor sem rosca

Ref. 289204



CONVERSÃO PARA **DECA DREAM / POLO**

ACQUA, ASPEN, AXIS, BELLE ÉPOQUE, MODELOS CLEAN, CONTEMPORANE, CUBO, DUNA, DUNA CLÁSSICA, DUNA QUADRATA, FLEX PLUS, IZY, IZYPLUS, LINIC, LINK, MAX, OXFORD, PRATA, QUADRATA, SKY, SPIN, SPOT, STANDARD, STAR, STUDIO, TARGA, TRADICIONAL E LIGHT, TUB, UNIC, WIDSOR E WISH



Cunha Emborrachada (EPDM)

PARA REGISTROS DE GAVETA

Liga de cobre e elastômeros
Temperatura máxima: 70 °C

PRODUTO PATENTEADO EXCLUSIVO



Ref. 289001 - nº 10	Ref. 289008 - nº 80	Ref. 289033 - nº 140	Ref. 289017 - nº 330
Ref. 289002 - nº 20	Ref. 289021 - nº 81	Ref. 289034 - nº 150	Ref. 289023 - nº 335
Ref. 289003 - nº 30	Ref. 289009 - nº 90	Ref. 289035 - nº 160	Ref. 289018 - nº 340
Ref. 289004 - nº 40	Ref. 289025 - nº 92	Ref. 289014 - nº 300	Ref. 289019 - nº 350
Ref. 289005 - nº 50	Ref. 289032 - nº 94	Ref. 289028 - nº 302	Ref. 289020 - nº 360
Ref. 289031 - nº 52	Ref. 289010 - nº 100	Ref. 289029 - nº 304	Ref. 289024 - nº 370
Ref. 289026 - nº 55	Ref. 289011 - nº 110	Ref. 289022 - nº 305	Ref. 289030 - nº 380
Ref. 289006 - nº 60	Ref. 289012 - nº 120	Ref. 289015 - nº 310	Ref. 289037 - nº 382
Ref. 289007 - nº 70	Ref. 289013 - nº 130	Ref. 289016 - nº 320	

UTILIZE O CASTELO DA INSTALAÇÃO ORIGINAL



MVS para Registro de Gaveta

DECA



Acabamento: Deca e similares
 Bitola: 3/4
 Ciclos: 10.000
 Estrias padrão **DECA** e similares

Ref. 289209 - **DECA ATUAL**
 Ref. 280103 - **DECA ANTIGO**

Rosca: nº 106 / Cunha: nº 90

O'ring Haste: 100802
 O'ring Castelo: 100851
 O'ring Módulo: 100825



MVS para Registro de Gaveta

DECA SEM CASTELO



Acabamento: Deca e similares
 Bitola: 3/4
 Ciclos: 10.000
 Estrias padrão **DECA** e similares (A)
 O'ring Haste: 100802

Ref. 280122 - **DECA** Atual cunha nº 170
 Ref. 280123 - **DECA** Antigo cunha nº 90



MVS para Registro de Gaveta

DECA



Acabamento: Deca e similares
 Bitola: 1
 Ciclos: 10.000
 Rosca: nº 112 / Cunha: nº 130
 Estrias padrão **DECA** e similares

Ref. 280107 - Completo
 Ref. 280131 - Haste e Cunha

O'ring Haste: 100802



MVS para Registro de Gaveta

DECA



Acabamento: Deca e similares
 Bitola: 1 1/4
 Ciclos: 10.000
 Rosca: nº 149 / Cunha: nº 335
 Estrias padrão **DECA** e similares

Ref. 280108 - Completo
 Ref. 280133 - Haste e Cunha

O'ring Haste: 100802



MVS para Registro de Gaveta

DECA



Acabamento: Deca e similares
 Bitola: 1 1/2
 Ciclos: 10.000
 Rosca: nº 140 / Cunha: nº 340
 Estrias padrão **DECA** e similares

Ref. 280109 - Completo
 1 Ref. 280130 - Haste e Cunha sem vedante
 2 Ref. 280132 - Haste e Cunha com vedante

O'ring Haste: 100802
 O'ring Castelo: 100851
 O'ring Módulo: 100831



MVS para Registro de Gaveta

DOCOL



Estria: Docol
 Bitola: 1
 Cunha: nº 130
 Ciclos: 10.000

Ref. 261622

LANÇAMENTO

MVS para Registro de Gaveta

DOCOL



Estria: Docol
 Bitola: 1. 1/2 (antigo) e 1. 1/4 (atual)
 Cunha: nº 311
 Ciclos: 10.000

Ref. 281623



MVS para Registro de Gaveta

DOCOL



Acabamento: Docol e similares
 Bitola: 1 1/2
 Ciclos: 10.000
 Estrias padrão **DOCOL** (B)

O'ring Haste: 100802
 O'ring Castelo: 100851
 O'ring Módulo: 100830

Rosca: nº 166/Cunha: nº 310
 1 Ref. 281612

Cunha: nº 150
 2 Ref. 281624



MVS para Registro de Gaveta

DOCOL



Acabamento: Docol e similares
 Bitola: 3/4
 Ciclos: 10.000
 Estrias padrão **DOCOL** e similares

Ref. 281619 - Docol Atual **(+VENDIDO)**
 Rosca: nº 102 / Cunha: nº 170

Ref. 281602 - Docol Antigo **(+VENDIDO)**
 Rosca: nº 102 / Cunha: nº 70

O'ring Haste: 100802
 O'ring Castelo: 100851
 O'ring Módulo: 100825



MVS para Registro de Gaveta

DOCOL SEM CASTELO



Acabamento: Docol e similares
 Bitola: 3/4
 Ciclos: 10.000
 Estrias padrão **DOCOL** e similares (A)
 O'ring Haste: 100802

1 Ref. 281618 - **DOCOL** Atual cunha nº 170
Haste com 1 vedante

2 Ref. 280124 - **DOCOL** Antigo cunha nº 70
Haste com 2 vedantes



MVS para Registro de Gaveta

TIGRE/FABRIMAR



Acabamento: Fabrimar e similares
 Bitola: 3/4
 Ciclos: 10.000
 Rosca: nº 103 / Cunha: nº 60
 Estrias padrão **FABRIMAR**

1 Ref. 282002 - Completo
 2 Ref. 282003 - Padrão Atual/**DECA**

Ref. 280125 - Haste e Cunha

O'ring Haste: 100802
 O'ring Castelo: 100851
 O'ring Módulo: 100825



MVS para Registro de Gaveta

MEBER - PARA HASTE COM TRAVA



Acabamento: Deca e similares
 Bitola: 3/4
 Ciclos: 10.000
 Modelo de base: Meber
 Rosca: nº 110 / Cunha: nº 80
 Estrias padrão **DECA** e similares

Ref. 283106 - Completo
 Ref. 283105 - Haste e Cunha

O'ring Haste: 100802
 O'ring Castelo: 100851
 O'ring Módulo: 100825



MVS para Registro de Gaveta

MEBER



Acabamento: Deca e similares
 Bitola: 3/4
 Ciclos: 10.000
 Modelo de base: Meber
 Rosca: nº 104 / Cunha: nº 81
 Estrias padrão **DECA** e similares

Ref. 283102 - Completo
 Ref. 280129 - Haste e Cunha

O'ring Haste: 100802
 O'ring Castelo: 100851
 O'ring Módulo: 100825



MVS para Registro de Gaveta

MEBER ANTIGO



Acabamento: Deca e similares
 Bitola: 3/4
 Ciclos: 10.000
 Modelo de base: Meber
 Rosca: nº 110 / Cunha: nº 80
 Estrias padrão **DECA** e similares

Ref. 283101 - Completo
 Ref. 280128 - Haste e Cunha

O'ring Haste: 100802
 O'ring Castelo: 100851
 O'ring Módulo: 100825



MVS para Registro de Gaveta

ORIENTE



Acabamento: Deca e similares
 Bitola: 3/4
 Ciclos: 10.000
 Modelo de base: Oriente antigo
 Estrias padrão **DECA** e similares (A)

O'ring Haste: 100802
 O'ring Castelo: 100851
 O'ring Módulo: 100825

Rosca: nº 110 / cunha: nº 80
 Ref. 282103

Rosca: nº 101 / cunha: nº 60
 Ref. 282101



MVS para Registro de Gaveta

TINCO



Acabamento: Deca e similares
 Bitola: 3/4
 Ciclos: 10.000
 Modelo de base: Meber
 Rosca: nº 115 / Cunha: nº 80
 Estrias padrão **DECA** e similares

Ref. 281401 - Completo
 Ref. 280127 - Haste e Cunha

O'ring Haste: 100802
 O'ring Castelo: 100851
 O'ring Módulo: 100825



Haste Registro de Gaveta



DECA

Material: Liga de cobre
Estrias padrão **DECA**

Base 1/2 e 3/4 atual
Ref. 050101

Base 3/4 antigo e 1
Ref. 050102

Base 1.1/4 e 1.1/2 atual
Ref. 050104 - Haster grossa
Ref. 050113

Base 1.1/2 estria antiga
Ref. 050105



Haste Registro de Gaveta



DECA

Material: Liga de cobre
Modelo 1510
Volante verde

Base 1/2 e 3/4
Ref. 050106

Base 1
Ref. 050107



Haste Registro de Gaveta



HIGI POP

Material: Liga de cobre
Estrias padrão **DECA**

Base 3/4
Ref. 058301



Haste Registro de Gaveta



DOCOL

Material: Liga de cobre
Estrias padrão **DOCOL**

1 Antiga
Base 1/2 e 3/4
Ref. 051601

2 Atual
Base 1/2 e 3/4
Ref. 051613



Haste Registro de Gaveta



MEBER

Material: Liga de cobre
Modelo antigo
Estrias padrão **DECA**

Base 3/4
Ref. 053102



Haste Registro de Gaveta



ORIENTE

Material: Liga de cobre
Modelo MO/95
Estrias padrão **DECA**

Base 3/4
Ref. 052105



Haste Registro de Gaveta



ORIENTE

Material: Liga de cobre
Modelo antigo
Estrias padrão **DECA**

Base 3/4
Ref. 052104



Haste Registro de Gaveta



RIO

Material: Liga de cobre
Estrias padrão **DECA**

Base 1/2, 3/4 e 1
Ref. 052601



Haste Registro de Gaveta



TINCO

Material: Liga de cobre
Estrias padrão **DECA**

Base 1/2, 3/4 e 1
Ref. 051401

MECANISMOS PARA MISTURADOR



Mecanismo para Misturador

MONOCOMANDO MULTIMARCAS

Diâmetro: 40 mm
Modelos: 190416, 190430, 190431, 190402, 190426 (ATUAL), 190404 e 190405

Compatível com: Japi, Kelly Linha Ocean 4441 FT, Perflex 2268, Lorenzetti 2257 E61, Imperatriz 4442, Meber 7001 C71 BA, LG Metais 43312, Pevilon 203145, Fani Linha Domus, Kimetais 1867, Talita 1443, Rainha 103392

Ref. 307110



Mecanismo para Misturador

MONOCOMANDO BLUKIT / MULTIMARCAS

Diâmetro: 35 mm

Ref. 307111



Mecanismo para Misturador

MONOCOMANDO DE TORNEIRA LAVATÓRIO, COZINHA E DUCHA DECA

Diâmetro: 40 mm

Ref. 300104



Mecanismo para Misturador

MONOCOMANDO DOCOL

Diâmetro: 35 mm
Modelos Swing, Swing Plus, Eclipse Banchu, Lavatório, Bidê e 190406

Ref. 300105

Confira como identificar o mecanismo para misturador em blukit.com.br/blog

Conversão para DECA DREAM / POLO

ACQUA, ASPEN, AXIS, BELLE ÉPOQUE, MODELOS CLEAN, CONTEMPORANE, CUBO, DUNA, DUNA CLÁSSICA, DUNA QUADRATA, FLEX PLUS, IZY, IZYPLUS, LINIC, LINK, MAX, OXFORD, PRATA, QUADRATA, SKY, SPIN, SPOT, STANDARD, STAR, STUDIO, TARGA, TRADICIONAL E LIGHT, TUB, UNIC, WIDSOR E WISH.

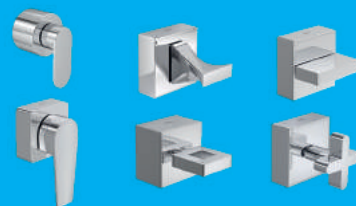

MVC - PARA REGISTROS DE PRESSÃO



MVC para Registro de Pressão

DECA DE 1/2 E 3/4

Liga de cobre e elastômeros
Acabamento: Deca Dream/Polo
Ciclos: 200.000
Rosca: nº 12
Estrias padrão **DOCOL**

Ref. 350109



Fabricado no Brasil



MVC para Registro de Pressão

DOCOL DE 1/2 E 3/4

Liga de cobre e elastômeros
Acabamento: Deca Dream/Polo
Ciclos: 200.000
Rosca: nº 07
Estrias padrão **DOCOL**

Ref. 351609

Haste cromada
Ref. 351613 - dry wall



Fabricado no Brasil



MVC para Registro de Pressão

ACQUA-SYSTEM/ TOP FUSION DE 3/4

Liga de cobre e elastômeros
Acabamento: Deca Dream/Polo
Ciclos: 200.000
Rosca: nº 37
Estrias padrão **DOCOL**

Ref. 358401



Fabricado no Brasil



MVC para Registro de Pressão

MEBER DE 1/2 E 3/4

Liga de cobre e elastômeros
Acabamento: Deca e similares
Ciclos: 200.000
Estrias padrão **DOCOL**

Ref. 353107 - Rosca: nº 43
Ref. 353103 - Rosca: nº 48
Sentido de abertura horário e anti-horário



Fabricado no Brasil



MVC para Registro de Pressão

TINCO DE 1/2 E 3/4

Liga de cobre e elastômeros
Acabamento: Deca Dream/Polo
Ciclos: 200.000
Rosca: nº 48
Estrias padrão **DOCOL**

Ref. 351404



Fabricado no Brasil



MVC para Registro de Pressão

TIGRE/FABRIMAR DE 1/2 E 3/4

Liga de Cobre e Elastômeros
Acabamento: Deca Dream/Polo
Ciclos: 200.000
Rosca: nº 19
Estrias padrão **DOCOL**

Ref. 352003



Fabricado no Brasil

MVS - PARA REGISTROS DE GAVETA



MVS para Registro de Gaveta

DECA

Liga de cobre e elastômeros
Bitola: 3/4
Ciclos: 10.000
Rosca: nº 106 / Cunha: nº 90
Estrias padrão **DOCOL**

Ref. 280119 - **DECA ATUAL**
Rosca: nº 155 / Cunha: nº 170

Ref. 280106 - **DECA ANTIGO**
Rosca: nº 106 / Cunha: nº 90



Fabricado no Brasil



MVS para Registro de Gaveta

DOCOL

Liga de cobre e elastômeros
Bitola: 3/4
Ciclos: 10.000
Rosca: nº 102 / Cunha: nº 70
Estrias padrão **DOCOL**

Ref. 281620 - **DOCOL ATUAL**
Rosca: nº 102 / Cunha: nº 170

Ref. 281604 - **DOCOL ANTIGO**
Rosca: nº 102 / Cunha: nº 70



Fabricado no Brasil



MVS para Registro de Gaveta

TIGRE/FABRIMAR

Liga de cobre e elastômeros
Bitola: 3/4
Ciclos: 10.000
Rosca: nº 103 / Cunha: nº 60
Estrias padrão **DOCOL**

Ref. 282004



Fabricado no Brasil

CONVERSORES PARA REGISTROS



Conversor



PARA REGISTRO DE PRESSÃO **DECA** DE 1/2 E 3/4

de: **DECA** para: **FABRIMAR**

Acabamento: Fabrimar de 1/2, 3/4 e 1

Ref. 130111



Conversor



PARA REGISTRO DE PRESSÃO **DECA** DE 1/2 E 3/4

de: **DECA** para: **DOCOL**

Acabamento: Docol e similares

Ref. 130101



Conversor



PARA REGISTRO DE PRESSÃO **DECA**

Liga de cobre e elastômeros

de: Reg. de pressão para: **DECA 1/2 e 3/4** para ponto de água de 1/2 BSP Macho

Altura: 60 mm | Aplicação: HIDRO. VERTICAL

Ref. 130169 - **DECA**

Ref. 131630 - **DOCOL**

Ref. 132030 - **FABRIMAR**



Castelo Conversor



PARA REGISTRO DE PRESSÃO E GAVETA **DOCOL**

de: **DOCOL** para: **DECA**

Acabamento: Deca e similares

Ref. 131613 - compr. 12 mm



Conversor



PARA REGISTRO DE PRESSÃO **DECA, RIO E TINCO**

de: **DECA, RIO E TINCO** para: **DOCOL**

Estria cromada

Acabamento: Docol e similares

Ref. 134901 - liga de cobre

Ref. 134903 - plást. de engenharia



Castelo Conversor



REGISTRO DE PRESSÃO E GAVETA **DECA**

Liga de cobre e elastômeros

Acabamento: Docol e similares

Ref. 130167



Castelo Conversor



PARA REGISTRO DE PRESSÃO E GAVETA **DOCOL**

de: **DOCOL** para: **DECA**

Acabamento: Deca e similares

Ref. 131601



Conversor



PARA REGISTRO DE PRESSÃO E GAVETA **DOCOL**

de: **DOCOL** para: **DECA**

Acabamento: Deca e similares

*castelo de plásticos de engenharia

Ref. 131623

LANÇAMENTO



Conversor



PARA REGISTRO DE PRESSÃO E GAVETA **DECA**

para **DOCOL**

Acabamento: **PRIMOR, PERTUTTI** e **INVICTA**

Ref. 134904



Conversor



PARA REGISTRO DE PRESSÃO E GAVETA **DOCOL**

de: **FABRIMAR** para: **DECA**

Acabamento: Deca e similares

Ref. 132001 **(+VENDIDO)**



Conversor

PARA REGISTRO DE GAVETA **DECA** DE 1/2 E 3/4 (ATUAL)

de: **DECA** para: **DOCOL**

Acabamento: Docol e similares

Ref. 130104

Obs: Ø rosca haste 7,7mm



Conversor



PARA VOLANTE **DOCOL**

Liga de cobre

Ref. 100109 - estria **DOCOL**

Ref. 100110 - estria **DECA**



Conversor

PARA REGISTRO DE PRESSÃO E GAVETA **FABRIMAR** DE 1/2, 3/4 E 1

de: **FABRIMAR** para: **DOCOL**

Acabamento: Docol e similares

Ref. 132002



Conversor

COM FURO LATERAL DE 9,4MM PARAFUSO DE FENDA LATERAL

Liga de cobre

Ref. 145901 - **DECA**



Conversor



PARA REGISTRO DE PRESSÃO E GAVETA **FABRIMAR** DE 1/2, 3/4 E 1

de: **FABRIMAR** para: **DECA**

Acabamento: Deca e similares

*castelo de plásticos de engenharia

Ref. 132026



Prolongador

PARA REGISTRO DE **PRESSÃO E GAVETA** PADRÃO **DECA** E SIMILARES

KIT COMPLETO EM LIGA DE COBRE

Acompanha estria, arruela e parafuso
 Ref. 160101 - cromado - 10 mm
 Ref. 160102 - cromado - 20 mm
 Ref. 160103 - cromado - 40 mm

SOMENTE O CASTELO

Ref. 160110 - cromado - 10 mm
 Ref. 160111 - cromado - 20 mm
 Ref. 160112 - cromado - 40 mm



KIT COMPLETO EM PLÁSTICO DE ENGENHARIA

Acompanha estria, arruela e parafuso

Ref. 160104 - cromado - 10 mm
 Ref. 160126 - branco - 10 mm
 Ref. 160105 - cromado - 20 mm
 Ref. 160127 - branco - 20 mm
 Ref. 160106 - cromado - 40 mm
 Ref. 160128 - branco - 40 mm

SOMENTE O CASTELO

Ref. 160113 - cromado - 40 mm
 Ref. 160129 - branco - 40 mm

SOMENTE A ESTRIA

Liga de cobre
 Ref. 160117 - cromado - 10 mm
 Ref. 160118 - dourado - 10 mm
 Ref. 160119 - s/acab. - 10 mm

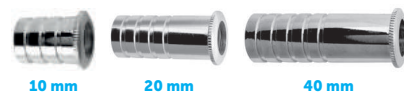

Prolongador

PARA REGISTRO DE PRESSÃO E GAVETA PADRÃO **DOCOL**

KIT COMPLETO EM LIGA DE COBRE

Acompanha estria, arruela e parafuso
 Ref. 161601 - sem acabamento - 10 mm
 Ref. 161618 - sem acabamento - 20 mm

SOMENTE O CASTELO EM LIGA DE COBRE

Ref. 161602 - sem acabamento - 10 mm
 Ref. 161611 - sem acabamento - 20 mm

KIT COMPLETO EM PLÁSTICO DE ENGENHARIA

Acompanha estria, arruela e parafuso
 Ref. 161607 - sem acabamento - 10 mm
 Ref. 161617 - sem acabamento - 20 mm

SOMENTE O CASTELO EM PLAST. DE ENG.

Ref. 161608 - sem acabamento - 10 mm

SOMENTE A ESTRIA

Liga de cobre DOCOL/FORUSI

Ref. 161612 - cromado - 10 mm
 Ref. 161603 - sem acabamento - 10 mm



Prolongador

PARA REGISTRO DE **PRESSÃO E GAVETA** PADRÃO **DECA** E SIMILARES

Prolonga estria e CASTELO

Ref. 160140

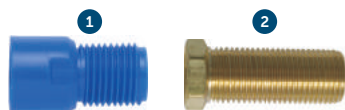

Prolongador de Castelo

PARA REGISTRO DE PRESSÃO E GAVETA PADRÃO **DECA** E SIMILARES

1 Plásticos de engenharia

Prolongamento útil: 15 mm
 Rosca: M14
 Ref. 160130

2 Liga de cobre

Prolongamento útil: 40 mm
 Rosca: M14
 Ref. 160121 - sem acabamento



Estria Prolongadora

PARA REGISTRO DE PRESSÃO E GAVETA

Liga de cobre

Prolongamento útil: 40 mm

Cromado

Ref. 160138 - Estria **DECA**
 Ref. 161619 - Estria **DOCOL**
 Ref. 160139 - Estria Int. **DECA** x Ext. **DOCOL**
 Ref. 161620 - Estria Int. **DOCOL** x Ext. **DECA**

Sem acabamento

Ref. 160123 - Estria **DECA**
 Ref. 161609 - Estria **DOCOL**
 Ref. 160124 - Estria Int. **DECA** x Ext. **DOCOL**
 Ref. 161610 - Estria Int. **Docol** x Ext. **DECA**



Estria Conversora

PARA REGISTROS

*acompanha parafuso

Liga de cobre

Estria interna: **DECA**
 Estria externa: **DOCOL**
 Ref. 140104 - cromado

Estria interna: **DOCOL**
 Estria externa: **DECA**

Ref. 141607 - compr. 18mm - cromado
 Ref. 141610 - compr. 12 mm - s/ acabamento
 Ref. 141602 - compr. 18 mm - s/ acabamento

Estria interna: **ORIENTE ANTIGA** (18 dentes)
 Estria externa: **DECA**
 Ref. 142102 - s/ acabamento



Prolongador Registro Pressão

Liga de cobre

Acabamento: Deca Dream, Polo, Twist, Dot e Level

Prolongamento útil: 30 mm
 * Aplicável no mecanismo do próprio fabricante (original)

Ref. 160136



Prolongador

PARA REGISTRO DE **GAVETA** PADRÃO **DECA** E SIMILARES

Liga de cobre

Acabamento: Deca Dream, Polo, Twist, Dot e Level

Comprimento: 47 mm
 * Aplicável no mecanismo do próprio fabricante (original)
 ** acompanha parafuso

Ref. 160135



Prolongador

PARA REGISTRO DE PRESSÃO E GAVETA PADRÃO **FABRIMAR** DE 1/2, 3/4 E 1

Liga de cobre

Prolongamento útil: 40 mm

Ref. 162004 - sem acabamento



Kit Prolongador

PARA REGISTRO DE PRESSÃO E GAVETA PADRÃO **DECA DREAM / POLO MODELO ANTIGO**

Liga de cobre

Prolongamento útil: 40 mm
 Estria: Padrão Docol

Ref. 160125 - sem acabamento



PROLONGADORES PARA REGISTROS



Prolongador



PARA REGISTRO DE PRESSÃO E GAVETA PADRÃO DECA E SIMILARES

Liga de cobre

Acabamento: Deca Dream, Polo, Twist, Dot e Level

Prolongamento útil: 30 mm

* Aplicável ao sistema de reparos Blukit

Ref. 160134 - estria cromada



Kit Prolongador



PARA MISTURADOR MONOCOMANDO DE CHUVEIRO DOCOL

Liga de cobre

Modelo: atual

Aplicação: Chuveiro Docol Atual.

Ref. 161614 - DOCOL Antigo - cromado

Ref. 161615 - DOCOL Atual Cartucho

40 mm - cromado

Ref. 161616 - DOCOL Atual Cartucho

45 mm - cromado



Kit Prolongador



PARA MISTURADOR MONOCOMANDO DE CHUVEIRO FABRIMAR

Liga de cobre

Ref. 162007 - sem acabamento



Kit Prolongador



PARA MISTURADOR MONOCOMANDO DE CHUVEIRO E DUCHA HIGIÊNICA DECA (ATUAL)

Liga de cobre

Comprimento: 57 mm

Ref. 160132 - prolongador monocomando DECA c/ cartucho original 35 mm

Ref. 160131 - prolongador monocomando DECA c/ cartucho original 40 mm

CONHEÇA O PORTAL DO LOJISTA



Blukit

+ PRATICIDADE
+ AGILIDADE
+ TRANSPARÊNCIA

TENHA ACESSO E MUITO MAIS!



CATÁLOGO



PEDIDOS



NOTAS



IMAGENS

portaldolojista.blukit.com.br



Tamanhos Maiores

1 ¼ e 1 ½

DECA e DOCOL

2 em 1

MAIOR



1 ¼ e 1 ½

Acabamento para Registros

PADRÃO DECA, DOCOL E SIMILARES

Plásticos de engenharia

Modelo: C-50

Ref. 090203 - cromado



1 ¼ e 1 ½

Acabamento para Registros

PADRÃO DECA, DOCOL E SIMILARES

Plásticos de engenharia

Modelo: C-37

Ref. 091703 - cromado

SOMENTE DECA
LIGA DE COBRE
Ref. 091901



Acabamento para Registros

PADRÃO DECA, DOCOL E SIMILARES

Plásticos de engenharia

Modelo: C-33

Ref. 090501 - cromado

Ref. 090502 - branco

Somente volante ABS

Ref. 070501 - cromado

Somente volante METAL

Ref. 071901 - cromado



SOMENTE DECA
LIGA DE COBRE
Ref. 092101

Acabamento para Registros

PADRÃO DECA, DOCOL E SIMILARES

Plásticos de engenharia

Modelo: C-37

Ref. 091701 - cromado

Ref. 091702 - branco

Ref. 091704 - preto

Somente volante ABS

Ref. 071701 - cromado



SOMENTE DECA
LIGA DE COBRE
Ref. 090801

Acabamento para Registros

PADRÃO DECA, DOCOL E SIMILARES

Plásticos de engenharia

Modelo: C-23

Ref. 090101 - cromado

Ref. 090102 - branco

Somente volante ABS

Ref. 070101 - cromado

Somente volante METAL

Ref. 070801 - cromado



SOMENTE DECA
LIGA DE COBRE
Ref. 090401

Acabamento para Registros

PADRÃO DECA, DOCOL E SIMILARES

Plásticos de engenharia

Modelo: C-52

Ref. 091601 - cromado

Ref. 091602 - branco

Somente volante ABS

Ref. 071601 - cromado

Somente volante METAL

Ref. 070401 - cromado

DECA & DOCOL

QUANDO DECA



Bucha para estria DECA

QUANDO DOCOL



Conversor de castelo DOCOL para DECA

Bucha para estria DOCOL

ACABAMENTOS

SOMENTE DECA
LIGA DE COBRE
Ref. 092001



Acabamento para Registros

PADRÃO DECA, DOCOL E SIMILARES

Plásticos de engenharia

Modelo: C-40

Ref. 091101 - cromado **(+VENDIDO)**

Ref. 091103 - branco

Ref. 091109 - preto

Somente volante ABS

Ref. 071101 - cromado



Acabamento para Registros

PADRÃO DECA, DOCOL E SIMILARES

Plásticos de engenharia

Modelo: C-43

Ref. 092501 - cromado

Ref. 092502 - branco



Acabamento para Registros

PADRÃO DECA, DOCOL E SIMILARES

Plásticos de engenharia

Modelo: C-50

Ref. 090201 - cromado **(+VENDIDO)**

Ref. 090202 - branco

Ref. 090207 - preto

Somente volante ABS

Ref. 070201 - cromado

SOMENTE DECA
LIGA DE COBRE
Ref. 091001



Acabamento para Registros

PADRÃO DECA, DOCOL E SIMILARES

Plásticos de engenharia

Modelo: C-45

Ref. 090301 - cromado **(+VENDIDO)**

Ref. 090302 - branco

Somente volante ABS

Ref. 070301 - cromado



Acabamento para Registros

PADRÃO DECA, DOCOL E SIMILARES

Plásticos de engenharia

Modelo: C-40 (Itapema)

Ref. 091102 - cromado **(+VENDIDO)**

Ref. 091104 - branco

Ref. 091110 - preto

Somente volante ABS

Ref. 071102 - cromado



DECA & DOCOL

QUANDO DECA



Conversor de castelo
DECA para DOCOL

Bucha para
estria DECA

QUANDO DOCOL



Bucha para
estria DOCOL



Acabamento para Registros

PADRÃO **DECA** E SIMILARES

Liga de cobre
Modelo: FIT

Ref. 092201 - cromado



Botão para Volante

PADRÃO **DECA** E SIMILARES

Plásticos de engenharia
Acabamento: Cromado

Ref. 100210



Botão

PARA MISTURADOR MONOCOMANDO

Plásticos de engenharia
Acabamento: Azul e Vermelho

Ref. 100209



Botão para Volante

COM SISTEMA DE PRESSÃO

Plásticos de engenharia
Acabamento:

Ref. 100207 - Azul
Ref. 100208 - Vermelho



Botão com Rosca para Volante

PADRÃO **DECA** E SIMILARES

Plásticos de engenharia
Acabamento: Preto/Cromado
Letra F = Fria

Ref. 100201



Botão com Rosca para Volante

PADRÃO **DECA** E SIMILARES

Plásticos de engenharia
Acabamento: Preto/Cromado
Letra Q = Quente

Ref. 100202



Kit Botão com Rosca para Volante

PADRÃO **DECA** E SIMILARES

Plásticos de engenharia
Acabamento: Branco/Cromado
5 pç letra Q = Quente
5 pç letra F = Fria

Ref. 100203



Botão com Rosca para Volante

PADRÃO **DECA** E SIMILARES

Plásticos de engenharia
Acabamento: Branco/Cromado
Letra F = Fria

Ref. 100204



Botão com Rosca para Volante

PADRÃO **DECA** E SIMILARES

Plásticos de engenharia
Acabamento: Branco/Cromado
Letra Q = Quente

Ref. 100205



Kit Botão com Rosca para Volante

PADRÃO **DECA** E SIMILARES

Plásticos de engenharia
Acabamento: Branco/Cromado
5 pç letra Q = Quente
5 pç letra F = Fria

Ref. 100206



Bucha Estriada

PARA VOLANTES

Plásticos de engenharia

- 1 Ref. 100306 - **DOCOL**
- 2 Ref. 100301 - **DECA**



Preme de Canopla Longo

FABRIMAR

Código Fabrimar: CPD 03256
Liga de cobre
Rosca Interna: nº 19
Estria Interna: padrão Fabrimar

Ref. 102132



Preme de Canopla

PARA **DECA** M14

Plásticos de engenharia
Com rosca passante
Comprimento: 10 mm

Ref. 100101



Preme de Canopla

PARA **DECA** M14

Plásticos de engenharia
Acabamento: Branco
Com rosca passante
Ref. 100112 - compr. 18 mm

Acabamento: Cromado
Com rosca passante: Ref. 100107 - compr. 20 mm
Sem rosca passante: Ref. 100102 - compr. 10 mm



Preme de Canopla

PARA **DOCOL** M22

Liga de cobre
Ref. 100108

Plásticos de engenharia
Ref. 100111



ACABAMENTOS



Aço Inoxidável



Fabricado no Brasil

Canopla

QUADRADA

Acabamento: Cromado Altura: 6 mm
Compr.: 60 mm x 60 mm
Ø Int.: 21 mm (1/2)

Aço inoxidável

Ref. 081321



Aço Inoxidável



Fabricado no Brasil

Canopla

COM ALETAS

Acabamento: Cromado Altura: 8 mm
Ø Ext.: 56 mm
Ø Int.: 21 mm

Aço inoxidável

Ref. 081304



Aço Inoxidável



Fabricado no Brasil

Canopla

COM ALETAS

Plásticos de engenharia
Acabamento: Cromado
Altura: 10 mm

Ø Int.: 21 mm (1/2)

Ø Ext.: 60 mm - Ref. 081305
Ø Ext.: 80 mm - Ref. 081306

Ø Int.: 26 mm (3/4)

Ø Ext.: 80 mm - Ref. 081311



Fabricado no Brasil

Canopla

COM ALETAS

Plásticos de engenharia
Acabamento: Cromado
Altura: 20 mm

Ø Int.: 21 mm (1/2)

Ø Ext.: 60 mm - Ref. 081314
Ø Ext.: 80 mm - Ref. 081315

Ø Int.: 26 mm (3/4)

Ø Ext.: 60 mm - Ref. 081310



Aço Inoxidável



Fabricado no Brasil

Canopla

PARA TORNEIRAS E OUTROS

Acabamento: Cromado
Altura: 5 mm
Ø Int.: 21 mm (1/2)

Aço inoxidável

Ø Ext.: 60 mm - Ref. 081302 (+VENDIDO)

Plásticos de engenharia

Ø Ext.: 60 mm - Ref. 081312
Ø Ext.: 80 mm - Ref. 081307



Fabricado no Brasil

Canopla

COM FURO REBAIXADO
PARA TORNEIRAS E OUTROS

Plásticos de engenharia
Acabamento: Cromado
Altura: 6 mm

Ø Ext.: 56 mm

Ø Int.: 21 mm - Ref. 081301
Ø Int.: 26 mm - Ref. 081401



Aço Inoxidável



Fabricado no Brasil

Canopla

COM FURO SEXTAVADO
E ALETAS PARA FLEXÍVEL

Aço inoxidável

Altura: 8 mm

Ø Ext.: 58 mm
Ø Int.: 21 mm (1/2)

Ref. 081303 (+VENDIDO)

Altura: 10 mm

Ø Ext.: 58 mm
Ø Int.: 27 mm (1)

Ref. 081404



Fabricado no Brasil

Canopla

COM FURO SEXTAVADO
E ALETAS PARA FLEXÍVEL

Plásticos de engenharia
Acabamento: Cromado
Altura: 7 mm

Ø Int.: 21 mm

Ø Ext.: 60 mm - Ref. 081308
Ø Ext.: 80 mm - Ref. 081309



Fabricado no Brasil

Canopla

COM ALETAS PARA EXTENSÕES
DE TORNEIRA 3/4

Plásticos de engenharia

Acabamento: Cromado

Altura: 10 mm

Ø Ext.: 60 mm

Ø Int.: 32 mm (1)

Ref. 081402



Fabricado no Brasil

Canopla

PARA VÁLVULAS E REGISTROS

Liga de cobre

Acabamento: Cromado
Altura: 8 mm
Ø Ext.: 50 mm
Ø Int.: 21 mm (1/2)

Ref. 081316



Fabricado no Brasil

Canopla com Preme

PARA REGISTROS

Plásticos de engenharia

Modelo: C-45 e C-50

Acabamento: Cromado

Altura: 18 mm

Ø Ext.: 56 mm

Ø Int.: 38 mm

Ref. 080701



Fabricado no Brasil

Canopla com Preme

PARA REGISTROS

Plásticos de engenharia

Modelo: C-45 e C-50

Acabamento: Cromado

Altura: 20 mm

Ø Ext.: 55 mm

Ø Int.: 51 mm

Ref. 080703



Canopla

COM **ROSCA INTERNA**
PARA TORNEIRAS

Liga de cobre e elastômeros

Altura: 4 mm
Diâmetro externo: 50 mm
Diâmetro/ Rosca Interna: 1/2
*acompanha vedante

Ref. 081318 - cromado



Prolongador de Canopla

PARA **REGISTROS DE 1/2, 3/4 E 1**

Acabamento: Cromado

Plásticos de engenharia

Ref. 102111 - 10 mm altura
Ref. 102112 - 20 mm altura
Ref. 102113 - 30 mm altura

Liga de cobre

Ref. 102101 - 10 mm altura
Ref. 102103 - 20 mm altura
Ref. 102105 - 30 mm altura



Prolongador de Canopla

PARA **REGISTRO DE GAVETA 1.1/4 e 1.1/2**

Acabamento: Cromado

Plásticos de engenharia

Ref. 102114 - altura 10mm
Ref. 102115 - altura 20mm
Ref. 102116 - altura 30mm



**DECA DREAM,
POLO, TWIST,
DROP, DOT E
LEVEL**

Prolongador de Canopla

PARA ACABAMENTO **DECA**

Plásticos de engenharia

Acabamento: Cromado

Ref. 102125 - compr. 10 mm
Ref. 102126 - compr. 20 mm
Ref. 102127 - compr. 30 mm
Ref. 081318 - cromado

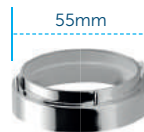

Prolongador de Canopla

PARA **REGISTROS**

Plásticos de engenharia

Acabamento: Cromado
Ø Ext.: 55 mm

Ref. 102124 - compr. 10 mm



Prolongador de Canopla

Plásticos de engenharia

Ref. 102117 - cromado



Prolongador de Canopla

PARA **REGISTROS**

Plásticos de engenharia

Diâmetro Ø: 59 mm

Ref. 102118 - diâmetro 59 mm
Ref. 102119 - diâmetro 55 mm



LANÇAMENTO



Plug Redondo

PARA **BIDÊS E LAVATÓRIOS**

Acabamento: Cromado
Canopla: 50 mm
Comprimento: 70 mm

Plásticos de engenharia

Ref. 091502 - rosca: 1/2 **(+VENDIDO)**
Ref. 091506 - rosca: 1/2 - preto

Liga de cobre

Ref. 091501 - rosca: M12



LANÇAMENTO



Plug Quadrado

PARA **BIDÊS E LAVATÓRIOS**

Acabamento: Cromado
Canopla: 50 mm
Comprimento: 70 mm

Plásticos de engenharia

Ref. 091503 - rosca: 1/2
Ref. 091505 - rosca: 1/2 - preto

Liga de cobre

Ref. 091504 - rosca: M12



PARA **GRELHA
QUADRADA**



Porta Grelhas

PARA CAIXAS SIFONADAS E RALOS

Aço inoxidável AISI 304

Acabamento: Cromado

Ref. 292105 - 100 mm
Ref. 292106 - 150 mm

PARA **GRELHA
REDONDA**



Porta Grelhas

PARA CAIXAS SIFONADAS E RALOS

Aço inoxidável AISI 304

Acabamento: Cromado

Ref. 292107 - 100 mm
Ref. 292108 - 150 mm

ACABAMENTOS

GRELHAS EM AÇO INOXIDÁVEL MAIS RESISTENTES E NÃO ENFERRUJAM



Aço Inoxidável

Grelha Quadrada com Fecho

PARA CAIXAS SIFONADAS E RALOS

Largura 100 mm
Ref. 291813 (+VENDIDO)

Largura 150 mm
Ref. 291814 (+VENDIDO)



Aço Inoxidável

Grelha Redonda com Fecho

PARA CAIXAS SIFONADAS E RALOS

Largura 100 mm
Ref. 291815 (+VENDIDO)

Largura 150 mm
Ref. 291816

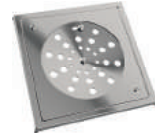

Aço Inoxidável

Grelha Quadrada com Fecho

COM CAIXILHO INTEGRADO, PARA CAIXAS SIFONADAS E RALOS

Largura 100 mm
Ref. 291817

Largura 150 mm
Ref. 291818

ACESSÓRIOS



Volante Acesso Restrito

PARA TORNEIRAS

Ref. 072301



Aço Inoxidável

Chave Acesso Restrito

COM ABRAÇADEIRA DE PARAFUSO

Largura: 9 mm

Ref. 101415 - Ø 12 a 16 mm
Ref. 101408 - Ø 12 a 20 mm
Ref. 101409 - Ø 16 a 25 mm
Ref. 101410 - Ø 20 a 32 mm



Aço Inoxidável

Abraçadeira com Parafuso

Largura: 9 mm

Ref. 101401 - Ø 12 a 20 mm
Ref. 101402 - Ø 16 a 25 mm
Ref. 101403 - Ø 20 a 32 mm

Aplicado ao flexível de gás ponta azul
Ref. 101416 - Ø 10 a 16 mm

DICA BLUKIT

Acesso restrito impossibilita o acionamento sem o volante



Aço Inoxidável



Liga de Cobre

Parafuso

TIPO **LENTILHA** PARA REGISTROS E TORNEIRAS

Cabeça: 7 mm
Roscas: 5/32 x 19 mm
Ref. 100515 - liga de cobre

Cabeça: 8 mm
Roscas: M4 x 16 mm
Ref. 100536 - liga de cobre

Cabeça: 9,5 mm
Roscas: 5/32 x 10 mm
Padrão **DECA, DOCOL, TINCO** e similares para fixar volantes
Ref. 100502 - aço inox.

Cabeça: 9,5 mm
Roscas: 5/32 x 16 mm
Padrão **DECA** para kit referência 131601
Ref. 100503 - liga de cobre

Cabeça: 9,5 mm
Roscas: 5/32 x 19 mm
Padrão **DECA** para kit prolongador de registros
Ref. 100504 - aço inox.

Cabeça: 9,5 mm
Roscas: 5/32 x 31 mm
Padrão **DECA** para kit prolongador de registros
Ref. 100505 - liga de cobre

Cabeça: 9,5 mm
Roscas: 5/32 x 35 mm
Ref. 100517 - liga de cobre

Cabeça: 9,5 mm
Roscas: 5/32 x 50 mm
Padrão **DECA** para kit prolongador de registros
Ref. 100506 - liga de cobre

Cabeça: 9,5 mm
Roscas: 3/16 x 10 mm
Padrão **ARGUS, MEBER, PERFLEX, FORUSI, IMETAL, POLY, ADRIÁTICA, FERBUC, MIL, METRILA, IBÉRICA, VULCÂNIA, ACQUA, PRIMAVERA**
Ref. 100509 - liga de cobre

Cabeça: 9,5 mm
Roscas: 3/16 x 19 mm
Padrão **ARGUS** e similares para kit conversores de registros
Ref. 100508 - liga de cobre

Cabeça: 9,5 mm
Roscas: 3/16 x 31 mm
Padrão **ARGUS** e similares para kit prolongador de registros
Ref. 100510 - liga de cobre

Cabeça: 9,5 mm
Roscas: 3/16 x 50 mm
Padrão **ARGUS** e similares para kit prolongador de registros
Ref. 100511 - liga de cobre



Parafuso



Fabricado no Brasil

TIPO **PANELA** PARA REGISTROS E TORNEIRAS

Liga de cobre

Cabeça: 5 mm
Rosca: 1/8 x 6 mm
Fixação do vedante bidê e lavatório Deca (antigo)
Ref. 100501

Cabeça: 5,5 mm
Rosca: 5/32 x 50 mm
Ref. 100523

Cabeça: 7 mm
Rosca: 5/32 x 15,5 mm
Ref. 100537

Cabeça: 7 mm
Rosca: 5/32 x 19 mm
Ref. 100530

Cabeça: 7 mm
Rosca: 5/32 x 31 mm
Ref. 100531

Cabeça: 7 mm
Rosca: 5/32 x 50 mm
Para Kit prolongador Deca / Docol
Ref. 100507

Cabeça: 7,5 mm
Rosca: 5/32 x 40 mm
Ref. 100534

Cabeça: 7,5 mm
Rosca: 5/32 x 70 mm
Ref. 100541



Parafuso

PROLONGADOR PARA REGISTRO
TIPO **LENTILHA**

Liga de cobre
Cabeça: 7 mm
Rosca: 5/32 x 80 mm
Ref. 100525

Cabeça: 9,5 mm
Rosca: 5/32 x 150 mm
Ref. 100560



Fabricado no Brasil



Parafuso

PROLONGADOR COM CABEÇA DE EMBUTIR

Liga de cobre
Acabamento: **DECA**
Modelo: **QUADRATA, QUADRATA CL, CUBO, ISI PLUS, CLEAN**
Roscas: 5/32 x 50 mm

Ref. 100529



Fabricado no Brasil



Parafuso

PROLONGADOR MACHO x FÊMEA

Liga de cobre
Cabeça: 6 mm
Comprimento: 50 mm

Ref. 100520
Rosca: 5/32 x 5/32

Ref. 100518
Rosca: 5/32 x 3/16

Ref. 100521
Rosca: 3/16 x 3/16



Fabricado no Brasil



AISI 304
ACO
INOX

Aço Inoxidável



Fabricado no Brasil

Parafuso

TIPO **ALLEN**

Ref. 100532
Roscas: M4 x 4 mm

VÁLVULAS E REGISTROS



Válvula

DE RETENÇÃO VERTICAL

Liga de cobre
Niquelado
Rosca: fêmea
Temperatura máxima: 60 °C

Ref. 330423 - bitola 3/4 **(+VENDIDO)**
Ref. 330421 - bitola 1
Ref. 330416 - bitola 1 1/2



Válvula

DE RETENÇÃO VERTICAL COM FILTRO DE TELA

Liga de cobre
Niquelado
Rosca: fêmea
Temperatura máxima: 60 °C

Ref. 330406 - bitola 1/2
Ref. 330418 - bitola 3/4 **(+VENDIDO)**
Ref. 330420 - bitola 1



Válvula

DE RETENÇÃO HORIZONTAL TIPO PORTINHOLA

Liga de cobre
Niquelado
Rosca: fêmea
Temperatura máxima: 60 °C

Ref. 330403 - bitola 1/2
Ref. 330422 - bitola 3/4 **(+VENDIDO)**
Ref. 330409 - bitola 1



2 em 1
3/4 e 1/2

Válvula

REDUTORA DE PRESSÃO

Liga de cobre
Niquelado
Pressão máxima: 120 m.c.a.
Rosca: fêmea
Temperatura máxima: 60 °C
Acompanha bucha redução PVC 3/4 x 1/2

Ref. 330313 - **2 em 1** - bitola 3/4 e 1/2 **(+VENDIDO)**
Ref. 330304 - bitola 2
Ref. 330303 - bitola 1 1/2



2 em 1
3/4 e 1/2

Válvula

REDUTORA DE PRESSÃO COM MANÔMETRO INTEGRADO

Liga de cobre
Niquelado
Pressão máxima: 80 m.c.a.
Roscas: fêmea
Temperatura máxima: 60 °C
Acompanha bucha redução PVC 3/4 x 1/2

Ref. 330311 - **2 em 1** - bitola 3/4 e 1/2



CONEXÕES - ÁGUA E FILTROS



Niple de Redução

Liga de cobre

Bitola: 1/2 x 3/8

Ref. 310502 - cromado (+VENDIDO)

Ref. 310503 - sem acabamento

1/2 x padrão Europa

Ref. 310501 - cromado

Ref. 310504 - cromado



Conversor

DE 1/2 X 3/8 PARA INSTALAÇÃO DE FILTRO (Ø10mm) E GÁS

Liga de cobre

Aplicação: Tubos de cobre 3/8, mangueira para filtro 10 mm e outros.

Bitola: 1/2 (M) x TC 3/8

Ref. 180910 - cromado



Bucha de Redução

PARA FILTRO EUROPA

Liga de cobre

Bitola: padrão Europa x 1/4

Padrão Filtros Europa (M) x (F) 1/4

Ref. 310103

1/2 (M) x (F) Padrão Filtros Europa

Ref. 310201



Adaptador para Filtro

Liga de cobre

Bitola: 3/4 x 1/4

Ref. 310132 - cromado

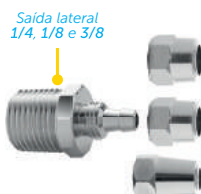

Adaptador 3 em 1

PARA FILTRO

Liga de cobre

Espigão: 1/8 (5 mm) e 1/4 (7 mm)

Rosca macho: 1/2

Ref. 310117 - cromado



Adaptador 3 em 1

SAÍDA 90 PARA FILTRO

Liga de cobre

Rosca: macho 3/8

Espigão: 1/4 (7 mm) e 1/8 (5 mm)

Ref. 310127 - cromado

Rosca: macho 1/2

Espigão: 1/4 (7 mm) e 1/8 (5 mm)

Ref. 310130 - cromado



Válvula Adaptador 3 em 1

DE VAZÃO PARA FILTROS

Liga de cobre

Espigão: 1/4 e 1/8

Rosca: macho 1/2 x fêmea 1/2

Pressão máxima: 40 m.c.a.

Ref. 310904 - cromado



Válvula Adaptador 3 em 1

DE VAZÃO PARA FILTROS

Liga de cobre

Espigão: 1/4 e 1/8

Rosca: macho 1/2

Pressão máxima: 40 m.c.a.

Ref. 310903 - cromado



Adaptador

PARA FILTRO **LORENZETTI**

Modelo: Versatile

Roscas: M24, M22, M21 e M19

Ref. 310123 (+VENDIDO)



Adaptador 3 em 1

UNIVERSAL PARA FILTRO

Liga de cobre

Bitola: 1/2

Rosca: macho x fêmea

Saída lateral para mangueiras:

de 1/4 (6,4mm)

de 1/8 (5 mm)

de 3/8 (9,5mm)

Ref. 310113 - cromado (+VENDIDO)



Adaptador 3 em 1

PAREDE PARA FILTRO

Liga de cobre

Bitola: 1/2

Rosca: macho x fêmea

Saída lateral para mangueiras:

de 1/4 (6,4mm)

de 1/8 (5 mm)

de 3/8 (9,5mm)

Ref. 310133 - cromado



Adaptador para Parede

PARA FILTRO

Liga de cobre

Bitola: 1/2
Rosca: Padrão Europa

Ref. 310134 - cromado



Adaptador para Parede

PARA FILTRO

Liga de cobre

Bitola: 1/2
Rosca: 1/4

Ref. 310135 - cromado



Adaptador para Torneira

COM SAÍDA LATERAL DE 45° PARA FILTRO E MÁQUINA DE LAVAR

Liga de cobre

Rosca Fêmea: 1/2 x 3/4
Rosca Macho: 1/2
Saída Lateral: 1/2

Ref. 310102 - cromado

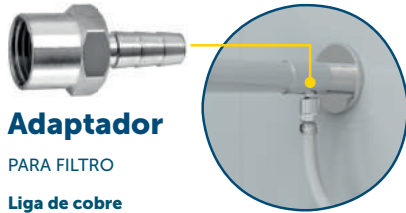

Adaptador

PARA FILTRO

Liga de cobre

Espigão: 3/16 (5 mm)
Rosca fêmea: 1/4

Compatível com a mangueira de filtro 310726

Ref. 310120 - cromado

Espigão: 1/4 (7 mm)

Rosca fêmea: 1/4

Compatível com a mangueira de filtro 310728

Ref. 310107 - cromado (+VENDIDO)

Espigão: 1/4 (7 mm)

Rosca fêmea: 1/2

Compatível com a mangueira de filtro 310728

Ref. 310110 - cromado

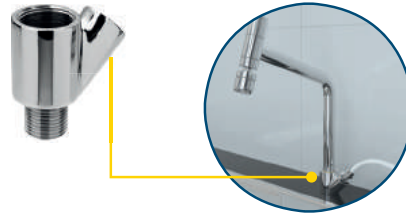

T de 45 Tipo Y

COM DESVIADOR PARA FILTRO

Liga de Cobre

Cromado

Rosca: macho x fêmea

Bitola: 1/2 x 3/4 x 1/2

Ref. 170204

Bitola: 1/2 x 1/2 x 1/2

Ref. 170233



T de Saída Dupla 1/2

Liga de Cobre

Rosca: 1/2 (M) x 1/2 (M) x 1/2 (M)

Bitola: 1/2 DN15

Ref. 170234



Plug

ROSCÁVEL

Liga de cobre

Bitola: M8

somente a CAPA
Ref. 310303

Ref. 310601 - cromado



Plug

PARA ARREIMATE COM ANEL

Liga de cobre

Bitola: 1/2

Ref. 171103 - cromado



Plug

ROSCÁVEL

Liga de cobre

Bitola: 1/2

Ref. 171113 - sem acabamento



EXCLUSIVO

Plug com Canopla em ABS



E PROLONGADOR DE CANOPLA

Liga de cobre

Cromado

Rosca: 1/2

Ref. 171101

Rosca: 0

Ref. 171102 - Compatível com as rosca dos módulos de redução. (para 3/4, usar o módulo 37)



Adaptador

PARA FILTRO

Liga de cobre

Rosca: fêmea 1/4

Espigão 1/4 (Ø7mm)

Ref. 310109 (+VENDIDO)

Espigão 1/8 (Ø5mm)

Ref. 310121



Adaptador

PARA FILTRO

Liga de cobre

Espigão: 1/4 (7 mm)

Rosca: macho 1/2

Compatível com mangueira de filtro 310728

Ref. 310118 - cromado (+VENDIDO)



Sem Plug



Com Plug



Instalação da mangueira direto no ponto de água



Instalação da mangueira no filtro

CONEXÕES - ÁGUA E FILTROS



Engate Rápido

PARA FILTRO

Liga de cobre

Pressão máxima: 40 m.c.a.
Temperatura máxima: 30 °C

Ref. 311037 - cromado **(+VENDIDO)**

Ø externo mangueira: 8 mm
Rosca: 1/2" (M)
Ref. 311038 - cromado

Ø externo mangueira: 9,7 mm
Rosca: 1/2" (M)
Ref. 311003 - cromado



Engate Rápido

TIPO JOELHO PARA FILTRO

Plásticos de engenharia

Pressão máxima: 40 m.c.a.
Temperatura máxima: 30 °C

Ø externo mangueira: 6,6 mm
Rosca: 1/4" (M)
Ref. 311005 - branco

Ø externo mangueira: 6,6 mm
Rosca: 1/2" (M)
Ref. 311041 - branco

Ø externo mangueira: 7,9 mm
Rosca: 1/4" (M)
Ref. 311006 - branco

Ø externo mangueira: 7,9 mm
Rosca: 1/2" (M)
Ref. 311034 - branco



Engate Rápido

EMENDA PARA FILTRO

Plásticos de engenharia

Pressão máxima: 40 m.c.a.
Temperatura máxima: 30 °C

Ø externo mangueira: 6,6 mm
Ref. 311013 - branco

Ø externo mangueira: 7,9 mm
Ref. 311040 - branco



Engate Rápido 90°

COM REGISTRO PARA FILTRO

Liga de cobre e plásticos de engenharia

Pressão máxima: 40 m.c.a.
Rosca: 1/2" (M)
Temperatura máxima: 30 °C

Ø externo mangueira: 6,6 mm
Ref. 311029

Ø externo mangueira: 7,9 mm
Ref. 311030

Ø externo mangueira: 9,4 mm
Ref. 311031

Ø externo mangueira: 12,6 mm
Ref. 311032



Engate Rápido Tipo T

PARA FILTRO

Plásticos de engenharia

Pressão máxima: 40 m.c.a.
Temperatura máxima: 30 °C

Ø externo mangueira: 6,6 mm
Ref. 311021 branco

Ø externo mangueira: 7,9 mm
Ref. 311022 branco

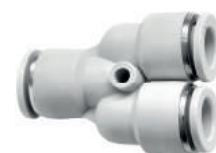

Engate Rápido Tipo T

PARA FILTRO

Plásticos de engenharia

Pressão máxima: 40 m.c.a.
Temperatura máxima: 30 °C

Ø externo mangueira: 6,6 mm
Ref. 311017 branco

Ø externo mangueira: 7,9 mm
Ref. 311018 branco

Ø externo mangueira: 12,5 mm
Ref. 311020 branco



EMBALAGEM 2 METROS

ROLO EM METRO

Mangueira Atóxica

PARA FILTROS

Plásticos de engenharia
Comprimento máximo: 50 m
Comprimento mínimo: 1 m
Pressão máxima: 30 m.c.a.
Temperatura máxima: 30 °C

Diâmetro externa: 6,6 mm
Diâmetro interna: 4,4 mm
Bitola: 1/8
Ref. 310726 - venda em metro **(+VENDIDO)**
Ref. 310730 - embalagem 2 m

Diâmetro externa: 9,4 mm
Diâmetro interna: 6,4 mm
Bitola: 1/4
Ref. 310728 - venda em metro
Ref. 310732 - embalagem 2 m

Diâmetro externa: 7,9 mm
Diâmetro interna: 6,4 mm
Bitola: 1/4
Ref. 310727 - venda em metro
Ref. 310731 - embalagem 2 m

Diâmetro externa: 12,5 mm
Diâmetro interna: 9,5 mm
Bitola: 3/8
Ref. 310729 - venda em metro
Ref. 310733 - embalagem 2 m

Confira abaixo as mangueiras em tamanho REAL

Bitola 3/8

Bitola 1/4

Bitola 1/4

Bitola 1/8



Instalação da mangueira no ponto de água com engate rápido



Instalação com regulador de vazão

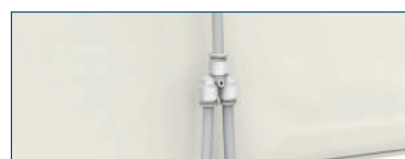

Instalação com engate rápido Y para ligação de dois filtros



Engate Rápido Tipo Joelho

PARA FILTRO

Plásticos de engenharia
Pressão máxima: 40 m.c.a.
Temperatura máxima: 30 °C

Ø externo mangueira: 6,8 mm
Ref. 311039 - branco

Ø externo mangueira: 8 mm
Ref. 311010 - branco

Ø externo mangueira: 9,6 mm
Ref. 311011 - branco

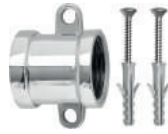

Luva

COM ALETAS PARA FIXAÇÃO

Liga de Cobre
Bitola: 1/2

Ref. 171013 - cromado



Luva

Liga de Cobre
Bitola: 1/2

Ref. 171003 - cromado
Ref. 171007 - sem acabamento



Luva

DE REDUÇÃO

Liga de Cobre
Bitola: 3/4 x 1/2

Ref. 171006 - cromado



Luva

COM PORCA GIRATÓRIA

Liga de cobre
Bitola: 1/2
Rosca: fêmea x fêmea

Ref. 171015 - niquelado



T de 90°

Liga de cobre
Rosca: fêmea
Bitola: 1/2

Ref. 170231 - cromado



Cruzeta

Rosca: fêmea
Bitola: 1/2

Ref. 172301 - sem acabamento
Ref. 172307 - cromado



Joelho de 90°

Liga de cobre
Rosca: fêmea
Bitola: 1/2

Ref. 170125 - cromado
Ref. 170113 - sem acabamento



Joelho de 90°

Liga de cobre
Rosca: macho x fêmea
Bitola: 1/2

Ref. 170126 - cromado
Ref. 170119 - sem acabamento



Joelho de 45°

Liga de cobre
Rosca: fêmea
Bitola: 1/2

Ref. 170105 - cromado



Joelho

COM ALETAS PARA FIXAÇÃO LATERAL

Liga de cobre
Rosca: fêmea
Bitola: 1/2

Ref. 170121 - cromado (Aletas laterais)
Ref. 170122 - cromado (Aletas frontais)



Joelho

ABS

Bitola: 1/2 x padrão Filtro Europa
Ref. 310401 - cromado



Desviador

Liga de cobre
Rosca: 1/2

Ref. 102301 - cromado

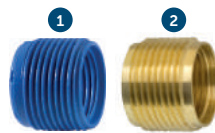

Bucha de Redução

Plásticos de engenharia
Bitola: 3/4 (DN20) x 1/2 (DN15)
Comprimento: 20 mm

1 Ref. 170308 - ABS

2 Ref. 170301 - latão



Bucha de Redução

INVERTIDA

Liga de cobre
Bitola: 3/4 (DN20) x 1/2 (DN15)
Rosca: invertida

Ref. 170401 - cromado
Ref. 170402 - sem acabamento



Bucha de Redução

COM SEXTAVADO EXTERNO

Liga de cobre
Comprimento: 20 mm

bitola 1/2 x 1/4
Ref. 170310 - cromado

bitola 1/2 x 3/8
Ref. 310202 - cromado

bitola 3/4 x 1/2
Ref. 170304 - cromado **(+VENDIDO)**

bitola 3/4 x 1/2
Ref. 170306 - sem acabamento

bitola 1 x 3/4
Ref. 170312 - sem acabamento

CONEXÕES - ÁGUA E FILTROS



Niple Duplo

Liga de cobre

Bitola: 1/2

Ref. 170621 - cromado **(+VENDIDO)**

Ref. 170620 - sem acabamento

Bitola: 3/4

Ref. 170606 - cromado

Ref. 170602 - sem acabamento

Plástico de engenharia

Bitola: 1/2

Ref. 170618 - branco

Ref. 170619 - cromado



Fabricado no Brasil



Niple

COM SOBRE PORCA GIRATÓRIA

Liga de cobre

Bitola: 1/2

rosca macho x fêmea

Ref. 170611 - cromado



Niple Paralelo

Liga de cobre

Bitola: 1/2

Comprimento 30mm

Ref. 170501 - sem acabamento

Comprimento 50mm

Ref. 170503 - sem acabamento



Niple de Redução

Liga de cobre

Bitola: 3/4 x 1/2

Ref. 170704 - cromado

Ref. 170705 - sem acabamento

Bitola: 1/2 x M14

Ref. 170713 - cromado



Aumento para Torneira e Chuveiros

Rosca: macho x fêmea

Liga de cobre

Sem acabamento

Bitola: 1/2

Comprimento 11 mm

Ref. 171601

Comprimento 21 mm

Ref. 171602

Comprimento 36 mm

Ref. 171603

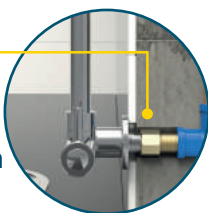

Fabricado no Brasil



Extensão

PARA CHUVEIROS E TORNEIRAS

Rosca: macho x fêmea

Bitola: 1/2

Liga de cobre

Ref. 171501 - compr. 20 mm - cromado

(+VENDIDO)

Ref. 171502 - compr. 40 mm - cromado

Ref. 171503 - compr. 60 mm - cromado

Ref. 171504 - compr. 100 mm - cromado

Plásticos de engenharia

Ref. 171514 - compr. 25 mm - branco

Ref. 171515 - compr. 25 mm - cromado

Ref. 171516 - compr. 40 mm - branco

Ref. 171517 - compr. 40 mm - cromado

Ref. 171519 - compr. 60 mm - cromado

Ref. 171520 - compr. 100 mm - branco

Ref. 171521 - compr. 100 mm - cromado



Fabricado no Brasil



Extensão

PARA TORNEIRAS

Rosca: Macho (60 mm) x Fêmea

Bitola: 1/2

Liga de cobre

Ref. 171510 - compr. 20 mm - cromado

Ref. 171511 - compr. 40 mm - cromado

Ref. 171512 - compr. 60 mm - cromado

Ref. 171513 - compr. 100 mm - cromado



Fabricado no Brasil



Aumento para Torneira e Chuveiros

Rosca: macho x fêmea

Liga de cobre

Bitola: 1/2

1 Cromado 13,5 mm

Ref. 171527

2 Sem acabamento 13,5 mm

Ref. 171528



Fabricado no Brasil

Sextavado interno, maior facilidade de instalação

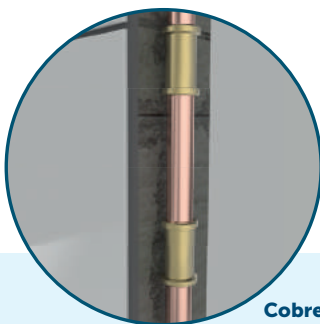

Cobre

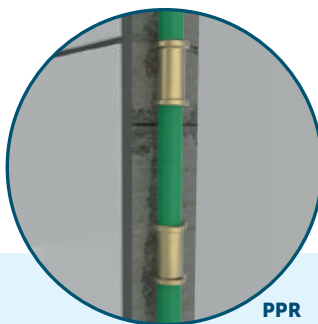

PPR

Luva de Correr para Tubulação de Cobre

Liga de cobre

Ø interno: 22 mm

Ref. 171019 - comprimento 53mm **(+VENDIDO)**

Ø interno: 28 mm

Ref. 171020 - comprimento 57mm

Ø interno: 15 mm

Ref. 171021 - comprimento 47mm



Fabricado no Brasil

Luva de Correr para Tubulação de PPR

Liga de cobre

Ø interno: 20 mm

Ref. 171023 - comprimento 53mm

Ø interno: 25 mm

Ref. 171024 - comprimento 57mm

Ø interno: 32 mm

Ref. 171025 - comprimento 47mm



Fabricado no Brasil

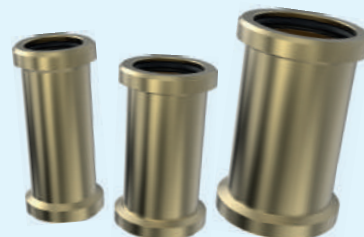



Adaptador

PARA INSTALAÇÃO DE GÁS

Não precisa de abraçadeira

Liga de cobre

Bitola: 1/2 (M) x espigão 3/8
Ref. 180101 - niquelado **(+VENDIDO)**
Ref. 180106 - sem acabamento



Adaptador

PARA INSTALAÇÃO DE GÁS

Liga de cobre

Bitola: 1/2 (F) x espigão 3/8
Ref. 180107 - sem acabamento

* Não precisa de abraçadeira



Adaptador Reto

PARA INSTALAÇÃO DE GÁS

Liga de cobre

Bitola: 1/2 (M) x TM 3/8
Ref. 180103 - niquelado **(+VENDIDO)**

* Usar a abraçadeira para fixação



Adaptador Reto

PARA INSTALAÇÃO DE GÁS

Liga de cobre

Bitola: 1/2 (F) x TM 3/8
Ref. 180104 - niquelado

* Usar a abraçadeira para fixação



Adaptador Vertical

PARA INSTALAÇÃO DE GÁS

Liga de cobre

Bitola: 1/2 (M) x TM 3/8
Ref. 180102 - niquelado **(+VENDIDO)**

* Usar a abraçadeira para fixação



Adaptador Vertical

PARA INSTALAÇÃO DE GÁS

Liga de cobre

Bitola: 1/2 (F) x TM 3/8
Ref. 180105 - niquelado

* Usar a abraçadeira para fixação



Luva

PARA GÁS

Liga de cobre

Bitola: 1/8 NPT (F) x 1/8 NPT (F)
Ref. 181002 - sem acabamento



Luva

PARA GÁS

Liga de cobre

Bitola: 1/2 BSP (F) x 3/8 BSP (F)
Ref. 181005 - sem acabamento

Bitola: 3/8 BSP (F) x 3/8 BSP (F)
Ref. 181006 - sem acabamento

Bitola: 1/2 BSP (F) x 1/2 BSP (F)
Ref. 181007 - sem acabamento



Anilha

PARA TUBO DE COBRE

Liga de cobre

Bitola: 3/8
Ref. 181506 - sem acabamento

Bitola: 1/2

Ref. 181508 - sem acabamento



Emenda

COM ANILHA PARA GÁS

Liga de cobre

Bitola: TC 3/8 x TC 3/8
Ref. 180952 - sem acabamento

Bitola: TC 1/2 x TC 1/2

Ref. 180962 - sem acabamento



Joelho de 90°

PARA GÁS COM PORCA

Liga de cobre

Bitola: 1/2 BSP (F) x 1/2 BSP (M)
Ref. 181817 - sem acabamento

* Não precisa de abraçadeira e flangeamento



Niple

PARA GÁS

Liga de cobre

Bitola: TC 1/2 x TC 1/2
Ref. 180935 - sem acabamento

Bitola: TC 3/8 x TC 3/8

Ref. 180934 - sem acabamento



Flange

PARA GÁS

Liga de cobre

Bitola: TC 1/2
Ref. 181510 - niquelado

Bitola: TC 3/8

Ref. 181509 - niquelado

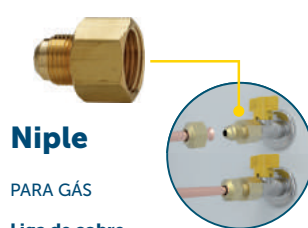

Niple

PARA GÁS

Liga de cobre

Bitola: 1/2 (DN15) BSP x 3/8 TC
Ref. 180926 - sem acabamento



Niple

COM ANILHA PARA GÁS

Liga de cobre

Bitola: 1/2 BSP (F) x TC 3/8
Ref. 180953 - sem acabamento

Bitola: 1/2 BSP (F) x TC 1/2

Ref. 180963 - sem acabamento

* Vedação por anilha

* Não precisa de flangeamento



Niple

COM ANILHA PARA GÁS

Liga de cobre

Bitola: 1/2 BSP (M) x TC 3/8
Ref. 180954 - sem acabamento

* Vedação por anilha

* Não precisa de flangeamento

ACESSÓRIOS PARA GÁS

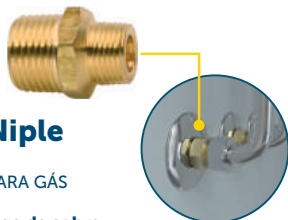

Niple

PARA GÁS

Liga de cobre

Bitola: 1/4 NPT (M) x 3/8 NPT (M)
Ref. 180925

Bitola: 1/2" NPT (M) x 1/2" NPT (M)
Ref. 180950



Niple

PARA GÁS

Liga de cobre

Bitola: 1/4 NPT x 1/2 (DN15) TC
Ref. 180904 - sem acabamento

Bitola: 3/8 NPT x 3/8 TC
Ref. 180923 - sem acabamento

Bitola: 1/2 (DN15) NPT x 3/8 TC
Ref. 180930 - sem acabamento

Bitola: 1/2 (DN15) NPT x 1/2 (DN15) TC
Ref. 180931 - sem acabamento



Niple

COM BORBOLETA PARA GÁS

Liga de cobre

Bitola: 1/8 NPT (M) x 5/8 UNC (M)
Ref. 182901 - niquelado

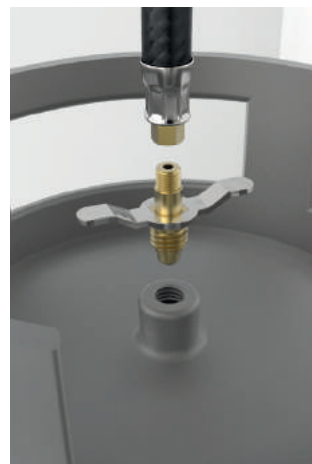

Niple

PARA GÁS

Liga de cobre

Bitola: 1/8 BSP (M) x 1/8 NPT (M)
Ref. 180909 - niquelado



Niple Conversor

PARA GÁS

Liga de cobre

M20 rosca esquerda (externa) mod. Liquegás x 7/8 rosca esquerda (externa) mod. Ultragás, Multigás, Butano, Minagás e outras marcas

Ref. 180901 - cromado

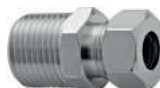

Conversor

CONVERSOR DE 1/2 X 3/8 PARA INSTALAÇÃO DE FILTRO (Ø10mm) E GÁS

Liga de cobre

Aplicação: Tubos de cobre 3/8, mangueira para filtro 10 mm e outros.

Bitola: 1/2 (M) x TC 3/8
Ref. 180910 - cromado



Válvula de Retenção

PARA GÁS

Liga de cobre

Bitola: 1/2 NPT (M) x 5/8 UNC (F)
Ref. 180801 - niquelado

Bitola: 1/2 NPT (M) x 7/16 NS (F)
Ref. 180802 - niquelado



Espigão

PARA MANGUEIRA DE GÁS

Liga de cobre

Sem acabamento
Bitola: 1/8 NPT x 3/8 TM
Ref. 181403

* Usar a abraçadeira para fixação



Espigão

LINHA INDÚSTRIA E JARDIM

Liga de Cobre

Sem acabamento
Bitola: 1/2 x 1/2
Espigão: 17,4 mm

Ref. 171303

* Usar a abraçadeira para fixação



Espigão

LINHA INDÚSTRIA E JARDIM

Liga de Cobre

Sem acabamento
Bitola: 3/4 x 3/4
Espigão: 22,5 mm

Ref. 171304

* Usar a abraçadeira para fixação



Espigão

PARA GÁS

Liga de cobre

Sem acabamento
Bitola: TC 3/8 x TM 3/8

Ref. 181413 - latão

* Usar a abraçadeira para fixação



Espigão

LINHA INDÚSTRIA E JARDIM

Liga de Cobre

Sem acabamento
Bitola: 1/2 x 3/8
Espigão: 14,2 mm

Ref. 171306

* Usar a abraçadeira para fixação



Espigão

PARA GÁS

Liga de cobre

Sem acabamento
Bitola: 1/2 NPT (M) x TM 3/8
Ref. 181411

Bitola: 3/8 NPT (M) x TM 3/8
Ref. 181414

* Usar a abraçadeira para fixação



Espigão

COM ANILHA PARA GÁS

Liga de cobre

Sem acabamento
Bitola: TC 3/8 x TM 3/8
Ref. 181415

Bitola: TC 3/8 x TM 1/2
Ref. 181416

* Usar a abraçadeira para fixação
* Vedação por anilha
* Não precisa de flangeamento

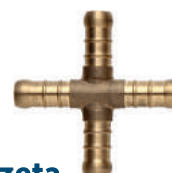

Cruzeta

PARA GÁS

Liga de cobre

Sem acabamento
Bitola: TM 3/8

Ref. 181202

* Usar a abraçadeira para fixação



"T"

PARA GÁS

Liga de cobre

Sem acabamento

Bitola: TM 3/8 x 1/2 NPT (M) x TM 3/8

Ref. 181307

* Usar a abraçadeira para fixação



"T"

PARA MANGUEIRA DE GÁS

Liga de cobre

Sem acabamento

Bitola: TM 5/16 (x3)

Ref. 181301

Bitola: TM 3/8 (x3)

Ref. 181318 **(+VENDIDO)**

* Usar a abraçadeira para fixação

NOMENCLATURA DAS CONEXÕES DE GÁS

- BSP** Cônica / Vedação por VEDANTE (Inglês)
- NPT** Cônica / Vedação por VEDANTE (Americano)
- UNF** Paralela / Vedação por FLANGEAMENTO
- UNS** Paralela / Vedação por FLANGEAMENTO
- UNC** Paralela / Vedação por FLANGEAMENTO
- TC** Tubo de Cobre
- TM** Terminal para Mangueira

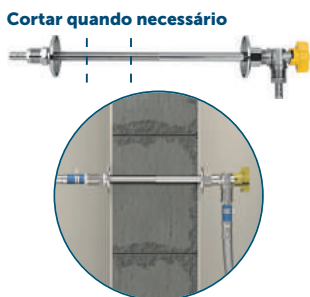

Passador de Parede

PARA GÁS COM REGISTRO INTEGRADO

Liga de cobre

Bitola: 1/2 x 3/8

Comprimento: 370 mm



soamente o PASSADOR

Ref. 180304 - cromado



Ligação Flexível

PARA INSTALAÇÃO DE GÁS

Passagem interna: 8 mm

Pressão máxima: 15 BAR

Rosca: 1/2 (F) x 1/2 (F)

Ref. 180426 - compr. 0,8 m

Ref. 180427 - compr. 1,0 m

Ref. 180423 - compr. 1,2 m

Ref. 180428 - compr. 1,5 m

Ref. 180429 - compr. 2,0 m



Ligação Flexível

PARA INSTALAÇÃO DE GÁS PARA ESPIGÃO DE 3/8

Passagem interna: 10 mm

Pressão máxima: 5 BAR

Ref. 182516 - compr. 0,8 m

Ref. 182517 - compr. 1,0 m

Ref. 182515 - compr. 1,2 m

Ref. 182518 - compr. 1,5 m

Ref. 182519 - compr. 2,0 m

Ref. 182521 - compr. 3,0 m



Ligação Flexível

PARA INSTALAÇÃO DE GÁS

Adaptador para espigão: 3/8

Passagem interna: 8 mm

Pressão máxima: 15 BAR

Rosca: 1/2 (F)

*acompanha adaptador integrado para espigão de 3/8

Ref. 181902 - compr. 1,0 m

Ref. 181912 - compr. 1,2 m

Ref. 181915 - compr. 1,5 m

Ref. 181913 - compr. 2,0 m

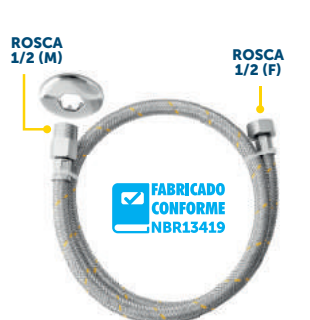

Ligação Flexível

PARA INSTALAÇÃO DE GÁS

Passagem interna: 8 mm

Pressão máxima: 15 BAR

Rosca: 1/2 (M) x 1/2 (F)

Ref. 180609 - compr. 0,4 m

Ref. 180622 - compr. 1,0 m

Ref. 180623 - compr. 1,2 m

(+VENDIDO)

Ref. 180611 - compr. 1,5 m

Ref. 180621 - compr. 2,0 m



Ligação Flexível

PARA INSTALAÇÃO DE GÁS

Passagem interna: 8 mm

Pressão máxima: 15 BAR

*acompanham 2 adaptadores integrados para espigão de 3/8

Ref. 182109 - compr. 1,2 m

Ref. 182104 - compr. 2,0 m



Ligação Flexível

PARA INSTALAÇÃO DE GÁS

Passagem interna: 8 mm

Pressão máxima: 15 BAR

Rosca: 1/2 (F) x 3/8 (F)

*acompanham adaptadores para espigão de 3/8 e ligação flexível

Ref. 180303 - compr. 1,2 m



Ligação Flexível

PARA INSTALAÇÃO DE GÁS

Passagem interna: 8 mm

Pressão máxima: 15 BAR

Rosca: 1/2 (F) x 1/2 (F)

*acompanha adaptador para espigão de 3/8, ligação flexível e registro de esfera

Ref. 180302 - compr. 1,2 m

ACESSÓRIOS PARA GÁS

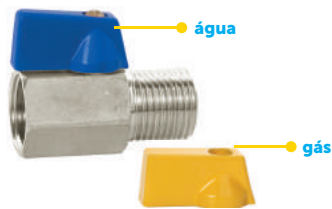

Registro

DE ESFERA PARA INSTALAÇÃO DE ÁGUA E GÁS

Liga de cobre

Pressão de serviço: 75 m.c.a.

Rosca: macho x fêmea

Temperatura máxima: 60 °C

***acompanha alavanca amarela**

Bitola: 3/8 BSP (F) x 3/8 BSP (M)

Diâmetro: DN 10

Ref. 330101 - niquelado

Bitola: 1/2 BSP (F) x 1/2 BSP (M)

Diâmetro: DN 15

Ref. 330113 - niquelado

Bitola: 3/4 BSP (F) x 3/4 BSP (M)

Diâmetro: DN 20

Ref. 330112 - niquelado



Kit para Aquecedor de Passagem

Pressão máxima: 15 BAR

Rosca: 1/2 (M) x 1/2 (F)

EMBALAGEM EXCLUSIVA

ACOMPANHA

- 1 - Ligação flexível para gás (passagem interna: 8 mm)
- 1 - Registro de esfera
- 2 - Ligações flexíveis para água quente e fria (passagem interna: 12 mm)
- 3 - Canoplas

Ref. 180517 - compr. 40 cm **(+VENDIDO)**



Ligação Flexível

COM JOELHO 90° PARA INSTALAÇÃO DE GÁS

Passagem interna: 8 mm

Pressão máxima: 15 BAR

Rosca: 1/2 (F) x 1/2 (F)

Ref. 182301 - compr. 30 cm

Ref. 182304 - compr. 40 cm

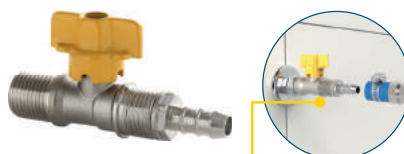

Registro

2 em 1

DE ESFERA PARA GÁS

Liga de cobre

Bitola: 1/2 x 1/2

Espigão: 3/8

Ref. 180291 - niquelado



Registro

DE ESFERA PARA GÁS

Liga de cobre

Bitola: 1/2 BSP (M) x 1/2 BSP (M)

Pressão de serviço: 75 m.c.a.

Ref. 180263 - niquelado



Registro

DE ESFERA COM ÂNGULO DE 90° PARA GÁS

Liga de cobre

Bitola: 1/2 BSP (M) x 1/2 BSP (M)

Pressão de serviço: 75 m.c.a.

Ref. 180260 - niquelado



Registro

DE ESFERA PARA GÁS

Liga de cobre

Bitola: 1/2 BSP (M) x 1/2 BSP (F)

Pressão de serviço: 75 m.c.a.

Ref. 180264 - niquelado



Registro

DE ESFERA PARA GÁS

Liga de cobre

Pressão de serviço: 75 m.c.a.

Bitola: 1/2" BSP (M) x TM 3/8"

Ref. 180261 - niquelado

(+VENDIDO)

Bitola: 3/8" BSP (M) x TM 3/8"

Ref. 180265 - niquelado

Bitola: 1/4" BSP (M) x TM 3/8"

Ref. 180262 - niquelado

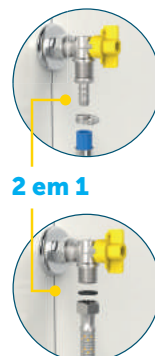

+SEGURANÇA Em caso de incêndio, o pino plástico derrete e corta o fluxo do gás.



Registro de Bloqueio

PARA INSTALAÇÃO DE GÁS

Material: Liga de cobre, plásticos de engenharia e elastômeros
Bitola: NPT 1/8 (M) x TM 3/8

Ref. 180280



Registro de Bloqueio

PARA INSTALAÇÃO DE GÁS

Material: Liga de cobre, plásticos de engenharia e elastômeros
Bitola: NPT 1/2 (M) x TM 3/8

Ref. 180273



Registro de Bloqueio

PARA INSTALAÇÃO DE GÁS

Material: Liga de cobre, plásticos de engenharia e elastômeros
Bitola: NPT 1/2 (M) x NPT 1/8 (F)

Ref. 180272



Registro de Bloqueio

PARA INSTALAÇÃO DE GÁS | 90°

Material: Liga de cobre, plásticos de engenharia e elastômeros
Bitola: NPT 1/2 (M) x NPT 1/2 (M)

Ref. 180270



Registro de Bloqueio

PARA INSTALAÇÃO DE GÁS

Material: Liga de cobre, plásticos de engenharia e elastômeros
Bitola: NPT 1/2 (M) x NPT 1/2 (M)

Ref. 180269



Registro de Bloqueio

PARA INSTALAÇÃO DE GÁS

Material: Liga de cobre, plásticos de engenharia e elastômeros
Bitola: NPT 1/8 (F) x NPT 1/8 (F)

Ref. 180268

ECONOMIZADORES DE ÁGUA

MULTI ADAPTÁVEL



Arejador Completo

NEOPERL COM ROSCA PADRÃO **DECA** (ANTIGO E ATUAL), **FABRIMAR** (ATUAL) E **DOCOL** (ATUAL)

Acabamento Cromado
Litros por minuto: 14 l
Roscas: M19, M21, M22 e M24

Plásticos de engenharia
Ref. 100615 (+VENDIDO)

Liga de cobre
Ref. 100601



MULTI ADAPTÁVEL



Arejador Completo

NEOPERL COM ARTICULADOR PARA TORNEIRA DE COZINHA PADRÃO **DECA** (ANTIGO E ATUAL), **FABRIMAR** (ATUAL) E **DOCOL** (ATUAL)

Acabamento Cromado
Litros por minuto: 14 l
Roscas: M19, M21, M22 e M24

Plásticos de engenharia
Ref. 100616

Liga de cobre
Ref. 100602 (+VENDIDO)



Arejador Completo

NEOPERL PADRÃO **DECA**

Liga de cobre / Plástico de engenharia e Elastômeros
Litros por minuto: 14 l
Rosca: M24 (atual)

Ref. 100603 - cromado



ECONOMIZADORES DE ÁGUA



Arejador Completo

PARA TORNEIRA **DOCOL**



Liga de cobre / Plástico de engenharia e Elastômeros

Rosca: M19

Ref. 100625 - cromado



Miolo

DE AREJADOR T1 **TIGRE/FABRIMAR**

Código Fabrimar: CPD 06186

Plásticos de engenharia

Sem acabamento

Ref. 100663



MULTI ADAPTÁVEL



Arejador Completo

NEOPERL TIPO SPRAY



Liga de cobre

Litros por minuto: 3,6 l

Roscas: M19, M21, M22 e M24

Ref. 100651 - cromado



Arejador Completo

NEOPERL PADRÃO **DECA** (ANTIGO)



Plásticos de engenharia / Elastômeros

Litros por minuto: 14 l

Rosca: M21

Ref. 100604 - cromado



Arejador

NEOPERL TIPO SPRAY



Plásticos de engenharia

Litros por minuto: 3,6 l

Rosca: M22

Ref. 100645 - sem acabamento



Arejador

NEOPERL



Plásticos de engenharia

Litros por minuto: 14 l

Diâmetro: 15 x 21 mm (maior)

Ref. 100630 - sem acabamento



Arejador Completo

NEOPERL PARA TORNEIRA TUBULAR SEM ROSCA



Liga de cobre

Diâmetro: 16 mm

Litros por minuto: 14 l

*acompanha chave Allen

Ref. 100613 - cromado



Arejador Completo

NEOPERL COM ADAPTADOR



Liga de cobre

Litros por minuto: 14 l

Rosca: fêmea de 3/4

Ref. 100610 - cromado



Ø 2,5 mm



Ø 4 mm



Ø 5,5 mm

Kit Redutor de Vazão

EM TERMOPLÁSTICO

Passagem de 2,5 mm

Ref. 172507 (+VENDIDO)



Fabricado no Brasil

ECONOMIZE ATÉ 60%



Redutor de Vazão

EM TERMOPLÁSTICO

Passagem de 2,5 mm
Ref. 172508



Fabricado no Brasil



Redutor de Vazão

EM TERMOPLÁSTICO

Passagem de 4 mm
Ref. 172509



Fabricado no Brasil



Redutor de Vazão

EM TERMOPLÁSTICO

Passagem de 5,5 mm
Ref. 172510



Fabricado no Brasil



Adaptador

COM REGULADORES DE VAZÃO EM TERMOPLÁSTICOS

Material: Liga de cobre
*Acompanha redutores com passagem de 2,5 mm, 4 mm e 5,5 mm

Ref. 172519 - cromado



Adaptador

COM REGULADOR DE VAZÃO CONSTANTE NEOPERL PARA CHUVEIROS E TORNEIRAS

Acabamento cromado
Rosca: 1/2 (MxF)
Comprimento: 25 mm
Vazão constante 8 litros/minuto

Plásticos de engenharia
Ref. 171523 - 8 litros/minuto



Fabricado no Brasil

Liga de cobre
Ref. 172515 - 6 litros/minuto
Ref. 172516 - 8 litros/minuto
Ref. 172514 - 14 litros/minuto



Redutor

COM PASSAGEM DE 2,5 MM

Liga de cobre
Bitola: 1/2

Ref. 172501 - sem acabamento



Regulador de Vazão

CONSTANTE NEOPERL

Litros por minuto: 6 l
Ref. 172511



Regulador de Vazão

CONSTANTE NEOPERL

Litros por minuto: 8 l
Ref. 172512



Regulador de Vazão

CONSTANTE NEOPERL

Litros por minuto: 14 l
Ref. 172513

EXTENSORES

MULTI ADAPTÁVEL



PRODUTO EXCLUSIVO



Extensor

COM AREJADOR NEOPERL PARA TORNEIRAS COM ROSCAS PADRÃO **DECA** (ANTIGO E ATUAL), **DOCOL** (ATUAL) E **FABRIMAR** (ATUAL)

Acabamento Cromado
Litros por minuto: 14 l
Roscas: M19, M21, M22 e M24

Liga de cobre
Ref. 110202 - compr. 90 mm
Ref. 110201 - compr. 140 mm

Plásticos de engenharia
Ref. 110204 - compr. 90 mm
Ref. 110205 - compr. 140 mm (+VENDIDO)



Extensor

COM AREJADOR NEOPERL PARA TORNEIRA TUBULAR

Liga de cobre
Acabamento Cromado
Litros por minuto: 14 l
Comprimento: 90 mm
*acompanha chave Allen

Ref. 110107 - compr. 90 mm

EXTENSORES



ECONOMIZE
ATÉ 50%

Extensor

COM AREJADOR NEOPERL PARA TORNEIRAS DE COZINHA **SEM ROSCA NA BICA**

Acabamento Cromado
Litros por minuto: 14 l
***acompanha abraçadeira**

Liga de cobre

Ref. 110102 - compr. 90 mm
Ref. 110101 - compr. 140 mm

Plásticos de engenharia

Ref. 110103 - compr. 90 mm
Ref. 110104 - compr. 140 mm **(+VENDIDO)**



TORNEIRAS

ACOMPANHA
REDUTOR
DE VAZÃO



BUCHA DE REDUÇÃO
1/2 X 3/4

Fabricado
no Brasil

Torneira Multiuso

COM ACIONAMENTO DE 1/4 DE VOLTA

Plásticos de engenharia

Bitola: 1/2
União: 3/4 x 1/2 (espigão)

Ref. 191527 - branco **(+VENDIDO)**
Ref. 191528 - cromado

BUCHA DE REDUÇÃO
1/2 X 3/4



1
nº 1 em
Vendas

Torneira

DE ESFERA PARA MÁQUINA DE LAVAR ROUPA E LAVA-LOUÇA

Bitola: 1/2
União: 3/4

Liga de cobre

Ref. 190121 - cromado **(+VENDIDO)**

Plásticos de engenharia

Ref.: 191540 - cromado

Fabricado
no Brasil



BUCHA DE REDUÇÃO
1/2 X 3/4

Torneira

DE ESFERA COM ACESSO RESTRITO PARA JARDIM

Liga de cobre

Bitola: 1/2
União: 3/4 x 1/2 (espigão)

Ref. 190122 - niquelado



BUCHA DE REDUÇÃO
1/2 X 3/4

Torneira

DE ESFERA COM ALAVANCA PARA JARDIM

Liga de cobre

Bitola: 1/2
União: 3/4 x 1/2 (espigão)

Ref. 190127 - niquelado **(+VENDIDO)**

EMBALAGEM
EXCLUSIVA





Torneira

DE ESFERA PARA JARDIM

Liga de cobre

Bitola: 1/2

União: 3/4 x 1/2 (espigão)

Ref. 190124 - niquelado

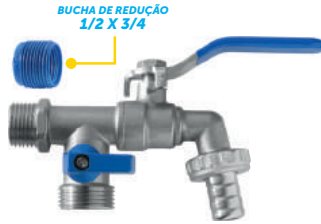

Torneira

DE ESFERA COM DERIVAÇÃO PARA JARDIM

Liga de cobre

Bitola: 1/2

União: 3/4 x 1/2 (espigão)

Ref. 190123 - niquelado



Torneira de 90°

DE ESFERA **COM FILTRO** PARA MÁQUINA DE LAVAR ROUPA E LAVA-LOUÇA

Liga de cobre

Bitola: 1/2

União: 3/4

Ref. 190125 - niquelado



Bucha de Redução Rosca nº 0

PARA MICTÓRIO

Liga de cobre

Bitola: nº 0 (M) x 1/2 (F)

Ref. 170405 - cromado



LANÇAMENTO



COM FECHAMENTO AUTOMÁTICO

- Normalizado
- Economia de Água

Válvula Temporizada

DE MICTÓRIO



Plástico de engenharia

Classe de pressão: 2 a 40 m.c.a.

Com canopla e ligação flexível

Kit completo

Ref. 190903 - branco

Ref. 190904 - cromado

Ref. 190908 - preto

Somente a válvula com canopla

Ref. 190905 - branco

Ref. 190906 - cromado



T Misturador

PARA MISTURADOR MONOCOMANDO

Liga de cobre

Bitolas: 1/2 x 3/8 x 3/8

Ref. 191102 - niquelado

Bitolas: 1/2 x 1/2 x 1/2

Ref. 191103 - niquelado



Kit de Fixação

PARA MICTÓRIO CELITE/ INCEPA/ LOGASA

Aço inoxidável, liga de cobre, plástico de engenharia e elastômero

Ref. 292004 - cromado



Redução Excêntrica

PARA MISTURADOR DE PAREDE

Liga de cobre

Bitolas: 3/4 x 1/2

Ref. 191114



Flange

PARA TORNEIRA

Rosca: 1/2

Liga de cobre

Ref. 191116

Plásticos de engenharia

Ref. 191167



Flange para Bica

DE MISTURADOR PADRÃO DECA

Liga de cobre

Rosca: M20

Ref. 191184 - sem acabamento

TORNEIRAS



T Ajustável

PARA MISTURADORES DE MESA

Poliacetel
 Bitolas: 1/2 x 1/2 x 1/2
 Classe de pressão: 2 a 40 m.c.a.
 Temperatura máxima: 60 °C

Ref. 191801

DICA BLUKIT
 Corte quando necessário

3 EXTREMIDADES COM O COMPRIMENTO REGULÁVEL



Kit de Fixação

PARA BICA

Bitola da torneira: 16 mm
 Ref. 192101 - sem acabamento



Kit de Vedação

PARA BICA MEBER, DOCOL E FABRIMAR

Bitola da torneira: 18 mm
 Ref. 192102 - sem acabamento



Lume

MECANISMO CERÂMICO

1/4 DE VOLTA

200 MIL CICLOS

Torneira Multiuso Longa

1/4 DE VOLTA | DE PAREDE

Material: Plásticos de Engenharia, Elastômeros e Cerâmicas
 Bitola: 1/2
 Normatizado ABNT NBR 10281
 Classe de pressão: 2 a 40 m.c.a.
 União: 3/4 x 1/2 (Espigão)
 COM PROTEÇÃO UV
Acompanha redutor de vazão e bucha de redução 1/2 x 3/4

Ref. 191557 - branco
 Ref. 191558 - cromado
 Ref. 191581 - preto



167 mm

Fabricado no Brasil



Lume

MECANISMO CERÂMICO

1/4 DE VOLTA

200 MIL CICLOS

Torneira Multiuso Curta

1/4 DE VOLTA PARA TANQUE/MÁQUINA

Material: Plásticos de Engenharia, Elastômeros e Cerâmicas
 Bitola: 1/2
 Normatizado ABNT NBR 10281
 Classe de pressão: 2 a 40 m.c.a.
 União: 3/4 x 1/2 (Espigão)
 COM PROTEÇÃO UV
Acompanha redutor de vazão e bucha de redução 1/2 x 3/4

Ref. 191559 - branco
 Ref. 191560 - cromado
 Ref. 191582 - preto



113 mm

Fabricado no Brasil



Lume

MECANISMO CERÂMICO

1/4 DE VOLTA

200 MIL CICLOS

Torneira com Derivação

1/4 DE VOLTA PARA TANQUE/MÁQUINA

Material: Plásticos de Engenharia, Elastômeros e Cerâmicas
 Bitola: 1/2
 Normatizado ABNT NBR 10281
 Classe de pressão: 2 a 40 m.c.a.
 União: 3/4 x 1/2 (Espigão)
 COM PROTEÇÃO UV
Acompanha redutor de vazão e bucha de redução 1/2 x 3/4

Ref. 191561 - branco
 Ref. 191562 - cromado
 Ref. 191583 - preto



160 mm

Fabricado no Brasil





Torneira Multiuso

1/4 DE VOLTA COM ACESSO RESTRITO

Material: Plásticos de Engenharia, Elastômeros e Cerâmicas

Bitola: 1/2

Normalizado ABNT NBR 10281

Classe de pressão: 2 a 40 m.c.a.

União: 3/4 x 1/2 (espigão)

COM PROTEÇÃO UV

Acompanha redutor de vazão e bucha de redução 1/2 x 3/4

Ref. 191569 - branco

Ref. 191570 - cromado



Torneira Multiuso

1/4 DE VOLTA COM ACESSO RESTRITO

Material: Plásticos de Engenharia, Elastômeros e Cerâmicas

Bitola: 1/2

Normalizado ABNT NBR 10281

Classe de pressão: 2 a 40 m.c.a.

União: 3/4 x 1/2 (espigão)

COM PROTEÇÃO UV

Acompanha redutor de vazão e bucha de redução 1/2 x 3/4

Ref. 191531 - branco

Ref. 191532 - cromado



União Torneira para Mangueira

Plástico de engenharia e elastômero

União: 3/4 x 1/2 (espigão)

Ref. 380609

Ref. 380610



TORNEIRAS



Torneira de Cozinha

1/4 DE VOLTA | DE PAREDE

Material: Plásticos de Engenharia, Elastômeros e Cerâmicas

Bitola: 1/2

Normalizado ABNT NBR 10281

Classe de pressão: 2 a 40 m.c.a.

COM PROTEÇÃO UV

Acompanha redutor de vazão e bucha de redução 1/2 x 3/4

Ref. 191545 - branco

Ref. 191546 - cromado

Ref. 191575 - preto



Fabricado no Brasil



Torneira de Cozinha

1/4 DE VOLTA | DE PAREDE

Material: Plásticos de Engenharia, Elastômeros e Cerâmicas

Bitola: 1/2

Normalizado ABNT NBR 10281

Classe de pressão: 2 a 40 m.c.a.

COM PROTEÇÃO UV

Acompanha redutor de vazão e bucha de redução 1/2 x 3/4

Ref. 191549 - branco

Ref. 191550 - cromado

Ref. 191577 - preto



Fabricado no Brasil



Torneira de Cozinha

1/4 DE VOLTA | DE MESA

Material: Plásticos de Engenharia, Elastômeros e Cerâmicas

Bitola: 1/2

Normalizado ABNT NBR 10281

Classe de pressão: 2 a 40 m.c.a.

COM PROTEÇÃO UV

Acompanha redutor de vazão

Ref. 191553 - branco

Ref. 191554 - cromado

Ref. 191579 - preto



Fabricado no Brasil



Torneira de Lavatório

1/4 DE VOLTA | DE MESA

Material: Plásticos de Engenharia, Elastômeros e Cerâmicas

Bitola: 1/2

Normalizado ABNT NBR 10281

Classe de pressão: 2 a 40 m.c.a.

COM PROTEÇÃO UV

Acompanha redutor de vazão

Ref. 191563 - branco

Ref. 191564 - cromado

Ref. 191584 - preto



Fabricado no Brasil



Reparo MVC 1/4 de Volta

PARA TORNEIRAS E REGISTROS BLUKIT

Estría DOCOL

Plástico de engenharia, elastômero, cerâmica e liga de cobre.
Vedantes do mecanismo 1/4 em Silicone.

Ref. 367113



Fabricado no Brasil

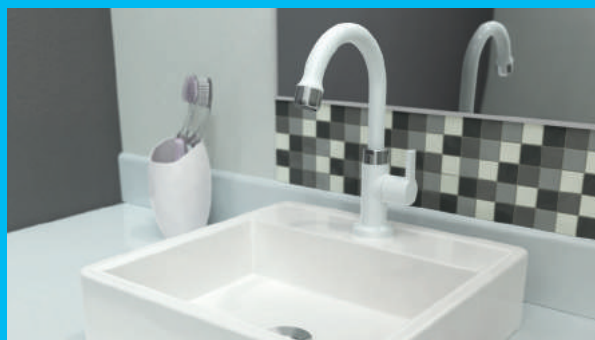



Blukit *Lume*



Fabricado no Brasil

Torneira de Cozinha

1/4 DE VOLTA | DE PAREDE

Material: Plásticos de Engenharia, Elastômeros e Cerâmicas

Bitola: 1/2

Normatizado ABNT NBR 10281

Classe de pressão: 2 a 40 m.c.a.

COM PROTEÇÃO UV

Acompanha redutor de vazão e bucha de redução 1/2 x 3/4

Ref. 191547 - branco

Ref. 191548 - cromado

Ref. 191576 - preto



Blukit *Lume*



Fabricado no Brasil

Torneira de Cozinha

1/4 DE VOLTA | DE PAREDE

Material: Plásticos de Engenharia, Elastômeros e Cerâmicas

Bitola: 1/2

Normatizado ABNT NBR 10281

Classe de pressão: 2 a 40 m.c.a.

COM PROTEÇÃO UV

Acompanha redutor de vazão e bucha de redução 1/2 x 3/4

Ref. 191551 - branco

Ref. 191552 - cromado

Ref. 191578 - preto



Blukit *Lume*



Fabricado no Brasil

Torneira de Cozinha

1/4 DE VOLTA | DE MESA

Material: Plásticos de Engenharia, Elastômeros e Cerâmicas

Bitola: 1/2

Normatizado ABNT NBR 10281

Classe de pressão: 2 a 40 m.c.a.

COM PROTEÇÃO UV

Acompanha redutor de vazão

Ref. 191555 - branco

Ref. 191556 - cromado

Ref. 191580 - preto



Blukit *Lume*



Fabricado no Brasil

Torneira de Lavatório

1/4 DE VOLTA | DE MESA

Material: Plásticos de Engenharia, Elastômeros e Cerâmicas

Bitola: 1/2

Normatizado ABNT NBR 10281

Classe de pressão: 2 a 40 m.c.a.

COM PROTEÇÃO UV

Acompanha redutor de vazão

Ref. 191565 - branco

Ref. 191566 - cromado

Ref. 191585 - preto



Fabricado no Brasil

Reparo MVC 1/4 de Volta

PARA TORNEIRAS E REGISTROS BLUKIT

Estria DOCOL

Plástico de engenharia, elastômero, cerâmica e liga de cobre
Vedantes do mecanismo 1/4 em Silicone.

Ref. 367113



TORNEIRAS



Torneira de Lavatório

1/4 DE VOLTA | DE MESA

Material: Plásticos de engenharia e elastômeros

Bitola: 1/2

Normatizado ABNT NBR 10281

Classe de pressão: 2 a 40 m.c.a.

COM PROTEÇÃO UV

Acompanha redutor de vazão

Ref. 191573 - branco

Ref. 191574 - cromado

Ref. 191587 - preto



Torneira Curva de Lavatório

1/4 DE VOLTA | DE MESA

Material: Plásticos de engenharia e elastômero

Bitola: 1/2

Normatizado ABNT NBR 10281

Classe de pressão: 2 a 40 m.c.a.

COM PROTEÇÃO UV

Acompanha redutor de vazão

Ref. 191571 - branco

Ref. 191572 - cromado

Ref. 191586 - preto



Torneira Curva Temporizada

DE MESA

Material: Plásticos de engenharia, elastômeros e aço inoxidável

Bitola: 1/2

Classe de pressão: 2 a 40 m.c.a.

Tempo de fechamento: 4 a 10 seg.

COM PROTEÇÃO UV

Acompanha redutor de vazão

Ref. 190228 - branco

Ref. 190229 - cromado

Ref. 190232 - preto

EM PLÁSTICOS ABS

PRODUTO
NORMATIZADO





Arejador antivandalismo

Torneira Temporizada de Parede

Material: Plásticos de engenharia, elastômeros e e aço inoxidável
 Bitola: 1/2

Classe de pressão: 2 a 40 m.c.a.
 Tempo de fechamento: 4 a 10 seg.

COM PROTEÇÃO UV
Acompanha redutor de vazão e bucha de redução 1/2 x 3/4

ECONOMIZE ATÉ 70%

200 MIL ABORNAMENTOS

Fabricado no Brasil

EM PLÁSTICOS ABS

Ref. 190226 - branco
 Ref. 190227 - cromado
 Ref. 190231 - preto

PRODUTO NORMALIZADO **Blukit**



Arejador antivandalismo

Torneira de Mesa Temporizada

Plástico de engenharia, elastômeros e aço inoxidável
 Bitola: 1/2

Classe de pressão: 2 a 40 m.c.a.
 Tempo de fechamento: 4 a 10 seg.

COM PROTEÇÃO UV
Acompanha redutor de vazão

Ref. 190234 - preto
 Ref. 190222 - branco
 Ref. 190223 - cromado

ECONOMIZE ATÉ 70%

200 MIL ABORNAMENTOS

Fabricado no Brasil

EM PLÁSTICOS ABS

PRODUTO NORMALIZADO **Blukit**



PRODUTO NORMALIZADO **Blukit**

Mecanismo para Torneira Temporizada

DOCOL

Plástico de engenharia, elastômeros e aço inoxidável
 Ciclos: 200.000

Classe de pressão: 2 a 40 m.c.a.
 Sistema temporizado

Ref. 027116 - sem regulagem
 Ref. 027115- com regulagem



PRODUTO NORMALIZADO **Blukit**

Mecanismo para Torneira Temporizada

2 em 1 BLUKIT | DOCOL

Plástico de engenharia, elastômeros e aço inoxidável
 Ciclos: 200.000

Classe de pressão: 2 a 40 m.c.a.
 Rosca: nº 40

Sistema temporizado

Ref. 027102

use a água de forma consciente:

CADA GOTA DO SEU ESFORÇO FAZ A DIFERENÇA

A Blukit conta com uma vasta linha de produtos **economizadores de água**, passando por torneiras, redutores de vazão, componentes, entre outros. Sempre aliando com conforto e qualidade, permitindo trazer até 80% de economia. Confira alguns deles:



Arejadores

Através das telas dos arejadores o ar é misturado a água, direcionando o jato, atenuando os respingos e **diminuindo o fluxo** sem reduzir a sensação do volume, gerando de 50 a 80% de economia!

ECONOMIZE
ATÉ **80%**

Extensores



ECONOMIZE
ATÉ **80%**

Com arejador embutido também conta com um jato de água eficiente e com menos respingos, sua **bica móvel** garante mais flexibilidade e agilidade no uso.



MVCs

O sistema possui abertura e fechamento de 1/4 de volta, trazendo um maior controle do fluxo da água, gerando mais economia em torneiras ou registros.



Redutores de Vazão

Conta com 3 modelos e tem a função de **restringir a vazão da água**, proporcionando economia sem perder o volume.

ECONOMIZE
ATÉ **60%**

Válvula para Mictório Temporizada

Ideais para ambientes coletivos, possui **fechamento automático** entre 4 a 10 segundos, evitando o uso contínuo.

ECONOMIZE
ATÉ **70%**

Obturador com Vedação em Silicone



ECONOMIZE
ATÉ **15%**

Permite a **regulagem da quantidade de água** que passa por ele, podendo gerar economia de até 15% de água.

Kits Caixa Acoplada Duplo Acionamento



Instalado na caixa acoplada, seu sistema duplo acionamento permite a utilização de meia descarga ou descarga completa.

ECONOMIZE
ATÉ **50%**

NUNCA FOI TÃO FÁCIL E ECONÔMICO ADQUIRIR PRODUTOS economizadores de água

Somos pioneiros em criar uma linha completa de torneiras temporizadas fabricadas em plástico ABS, oportunizando assim uma **dupla economia: tanto de água como para o bolso!** Afinal, o valor de mercado de uma temporizada de metal é bastante superior e não acessível a muitos consumidores e estabelecimentos.

Entre os modelos da linha podem ser encontrados a tradicional torneira temporizada de mesa/bancada, um modelo exclusivo de parede e uma opção curva de mesa, oferecendo mais elegância para o ambiente.

Além de proporcionar **70% de economia de água** e atender as normas técnicas brasileiras, as torneiras temporizadas Blukit trazem inúmeras qualidades: **contam com mais de 200 mil acionamentos**, possuem **proteção contra raios UV** (evitando o amarelamento da peça) e contam com **arejador antivandalismo** (evitando o furto em locais de acesso público).

Sempre entendemos a importância da preservação do meio ambiente e de sermos uma empresa com atitudes conscientes. Ao longo do tempo, além de investir em todos esses produtos economizadores, evoluímos com ações por todos os parques fabris para **gerar o menor impacto possível em relação ao desperdício de água.**



Torneiras Temporizadas

Com maior **controle do tempo de vazão da água**, entre 4 a 10 segundos, o funcionamento automático temporizado libera apenas a quantidade necessária para cada acionamento.





BLUKIT METALÚRGICA LTDA.

CNPJ: 81.604.803/0001-57

Rua João Pessoa, 2566 - CEP: 89036-003
Velha - Blumenau/SC - Brasil

BLUKIT INDÚSTRIA DE PLÁSTICOS LTDA.

CNPJ: 09.641.520/0001-58

Rua Marconi, 310 - CEP: 89066-030
Itoupavazinha - Blumenau/SC - Brasil

falecom@blukit.com.br

55 47 3331-0800

Conheça nossa linha
completa de produtos em:

blukit.com.br

©   **canalblukit**